

8640B SIGNAL GENERATOR

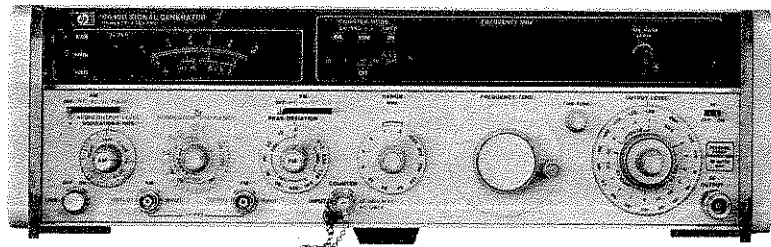

HEWLETT  PACKARD

General

This produce and related documentation must be reviewed for familiarization with safety markings and instructions before operation.

WARNINGS

An interruption of the protective (grounding) conductor inside or outside the instrument or disconnection of the protective earth terminal is likely to make the apparatus dangerous. Intentional interruption is prohibited.

Whenever it is likely that the protection has been impaired, the instrument must be made inoperative and be secured against any unintended operation.

Make sure that only fuses with the required rated current and of the specified type (normal blow, time delay, etc.) are used for replacement. The use of repaired fuses and the short-circuiting of fuseholders must be avoided.

Any adjustment, maintenance, and repair of the opened instrument under voltage should be avoided as much as possible and, when inevitable, should be carried out only by a skilled person who is aware of the hazard involved. The opening of covers or removal of parts, except those to which access can be gained by hand, may expose live parts, and also accessible terminals may be live.

Capacitors inside the instrument may still be charged even if the instrument has been disconnected from its source of supply.

Multi-Function Meter and Annunciators (Cont'd)

1-54. The REDUCE FM VERNIER annunciator lights whenever the FM input and FM vernier setting combine to exceed the 1 volt drive level required for maximum deviation indicated on the PEAK DEVIATION range switch. When this occurs, either the FM vernier or the amplitude of the incoming modulation signal should be reduced to obtain specified FM performance.

1-55. Output Level

1-56. The wide output range of the generator is achieved with a 10 dB step attenuator and a concentric vernier. Output levels are read on the meter. Meter scales are selected automatically.

1-57. The maximum output level of +19 dBm permits high level tests on receiver IF's, amplifiers, and mixers without additional power amplification. At the same time, extremely low leakage enables receiver sensitivity measurements down to levels of 0.03 μ V in a shielded system.

1-58. OPTIONS

1-59. **Option 001.** Option 001 (documented in this manual) provides a modulation oscillator that is continuously adjustable from 20 Hz to 600 kHz. The oscillator can also be set for 400 Hz or 1 kHz fixed tones. Option 001 may be retrofitted.

1-60. **Option 002.** Option 002 (documented in this manual) provides an internal, active frequency doubler that extends the frequency range of the generator to 1024 MHz (to 1100 MHz with over-range). Option 002 is available only as a factory installed option.

1-61. **Option 003.** Option 003 (documented in this manual) protects the generator's output circuits from accidental applications of reverse power up to 50 watts. Option 003 may be retrofitted.

1-62. **Option 004.** Option 004 (documented in a separate manual) provides a demodulated output and modified AM circuitry for setting very accurate AM depths. It also has a 1 dB output step attenuator in addition to the standard 10 dB output step attenuator. These features allow the generator to be used to test VOR, ILS, and VHF communications receivers. Option 004 is available only as a factory installed option.

1-63. **Option 005.** Option 005 (documented in a separate supplement to this manual) provides improved output level accuracy and lower guaranteed single sideband phase noise. It also has a 1 dB out-

put step attenuator in addition to the standard 10 dB output step attenuator. These features allow the generator to more accurately test high performance HF, VHF, and UHF receivers. Option 005 is available only as a factory installed option.

1-64. ACCESSORIES SUPPLIED

1-65. The Model 8640B is supplied with the following accessories:

Line Power Cable (refer to paragraph 2-12)
1.25 Amp Fuse (HP 2110-0094)
Combination Wrench (HP 08640-00027,
mounted inside chassis).

1-66. ELECTRICAL EQUIPMENT AVAILABLE

1-67. **Down Converter.** The HP Model 11710B Down Converter is a self-contained unit that extends the frequency range of the generator down to 10 kHz. This is accomplished by heterodyning a 50.01 to 61 MHz output from the generator with a 50 MHz local oscillator. Output level and modulation calibration of the Signal Generator are preserved, and the output frequency is that displayed by the generator minus 50 MHz. For convenience the output of the Down Converter can be switched to provide direct output from the Signal Generator.

1-68. **Variable Frequency Modulation Oscillator Retrofit Kit (HP 08640-60076).** This kit contains all the necessary components and full instructions for installation of the variable frequency modulation oscillator. After installation and calibration, performance will be identical to the 8640B Option 001 specifications.

1-69. **Reverse Power Protection Retrofit Kit.** The HP Model 11699A Reverse Power Protection Retrofit Kit contains all the necessary components and full instruction for installation of the reverse power protection. Installation of the kit is very simple and minimum recalibration is required. After installation and calibration, performance will be identical to the 8640B Option 003 specifications.

1-70. **Termination.** The HP Model 11507A Termination maintains the generator's output level calibration when the output is connected to load impedances other than 50 ohms. It can provide source impedances of 25 and 5 ohms, and can simulate a broadcast-band dummy antenna. The frequency range is 50 kHz to 65 MHz.

ELECTRICAL EQUIPMENT AVAILABLE (Cont'd)

1-71. 75-Ohm Adapter. The HP Model 11687A 50-to-75 Ohm Adapter connects to the generator's output to provide a source impedance of 75 ohms.

1-72. Doubler. The HP Model 11690A Doubler extends the usable frequency range of the generator without Option 002 one octave to 1024 MHz (actually to 1100 MHz with 7% frequency over-range). Conversion loss in the doubler is typically <13 dB.

1-73. Bandpass Filters. For Option 002, the HP Models 11697A, B, and C Bandpass Filters connect to the RF OUTPUT jack to eliminate harmonic and subharmonic related signals. Figures 1-7 and 1-8 illustrate the advantage of using these bandpass filters. However, a small insertion loss (typically less than 1.1 dB), and impedance mismatch error (typically less than ±0.2 dB) will be introduced into the measurement system which will affect output power, and level accuracy. (Mismatch error is maximum at maximum RF output but can be substantially reduced by increasing the generator's output attenuation.)

Filter	Pass Band
HP 11697A	512-674 MHz
HP 11697B	674-890 MHz
HP 11697C	800-1100 MHz

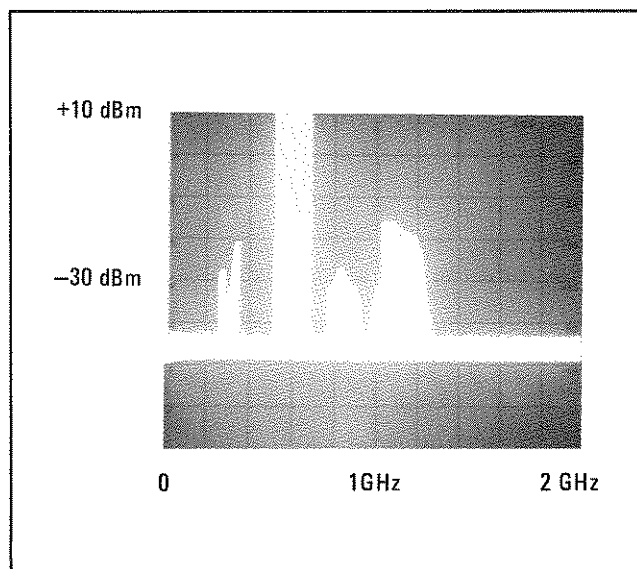

Figure 1-7. RF Output, 512-674 MHz, Without Bandpass Filter (Option 002)

1-74. MECHANICAL EQUIPMENT AVAILABLE

1-75. The following equipment may have been ordered and received with the Signal Generator. If they were not received with the original shipment and are now required, they must be ordered from your nearest Hewlett-Packard office using the part number included in each of the following paragraphs.

1-76. Rack Flange Kit. A rack mount kit is available (HP 5060-8740). This kit contains all the necessary hardware and installation instructions for mounting the instrument on a rack with 482.5 mm (standard 19-inch) spacing.

1-77. Chassis Slide Mount Kit. This kit is extremely useful when the Signal Generator is rack mounted. Access to internal circuits and components or the rear panel is possible without removing the Generator from the rack. Order HP part number 1490-0714 for 558.8 mm (22 in.) fixed slides and part number 1490-0721 for the correct adapters.

1-78. Protective Cover. The HP 5060-8767 Control Panel Cover protects the front panel from dust and impact damage.

1-79. Instrument Transit Case. The HP 9211-0839 is a rugged protective fiberglass case with molded urethane pads to protect the Signal Generator against dust, moisture, and shock. Included with the case are carrying handles which fold flat when not in use.

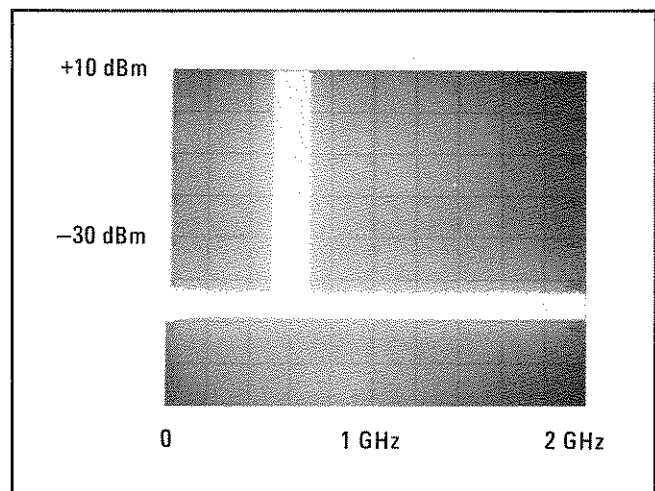

Figure 1-8. RF Output, 512-674 MHz with HP 11697A Bandpass Filter (Option 002)

1-80. SERVICE AND USER AIDS

1-81. Video Tapes. Video tapes covering instrument use, application, and service are available. Contact the nearest Hewlett-Packard Sales and Service Office for a list of presently available tapes.

1-82. Application Notes. Informative notes concerning the use of signal generators are also available from the nearest Hewlett-Packard Sales and Service Office.

1-83. Service Notes. Hewlett-Packard makes design improvements to its current line of instruments on a continuing basis. Many of these improvements can be incorporated in instruments produced earlier. Modification and general service information is passed on in the form of Service Notes. To obtain the Service Notes, contact the nearest Hewlett-Packard Sales and Service Office.

1-84. WARRANTY

1-85. The Signal Generator is warranted and certified as indicated on the inside front cover of this

manual. For further information, contact the nearest Hewlett-Packard Sales and Service Office; addresses are provided at the back of this manual.

1-86. TEST EQUIPMENT REQUIRED

1-87. Tables 1-2 and 1-3 list the test equipment and accessories required to check, adjust and repair the Signal Generator, including Options 001, 002, and 003. (Table 4-1 is a separate list of relatively inexpensive, commonly available test equipment for the Basic Functional Check only.) If substitute equipment is used it must meet the listed critical specifications.

1-88. SAFETY CONSIDERATIONS

1-89. The safety classification of this instrument is Safety Class I (provided with a protective earthing terminal). The instruction manual contains information, warnings, and cautions which must be followed by the user to ensure safe operation and to retain the instrument in safe condition.

Table 1-1. Specifications (1 of 7)

(All specifications apply over the nominal Frequency Ranges and over the top 10 dB of the output level vernier range unless otherwise specified.)

FREQUENCY

Range: 500 kHz to 512 MHz in 10 octave ranges.

Option 002 (Internal Doubler): 500 kHz to 1024 MHz in 11 octave ranges.

Ranges and Range Overlap: Ranges extend approximately 10% below and 7% above the nominal Frequency Ranges shown below:

Frequency Ranges (MHz)	Frequency Range (MHz) (with overlap)
0.5 - 1	0.45 - 1.07
1 - 2	0.90 - 2.14
2 - 4	1.80 - 4.29
4 - 8	3.60 - 8.59
8 - 16	7.20 - 17.1
16 - 32	14.4 - 34.3
32 - 64	28.8 - 68.7
64 - 128	57.5 - 137
128 - 256	115 - 275
256 - 512	230 - 550
512 - 1024 ¹ (Option 002)	460 - 1100

Accuracy: 6-digit LED display² with X10 and X100 expand; accuracy depends on internal or external reference used.

$$\left[\begin{array}{c} \text{Total} \\ \text{Count} \\ \text{Accuracy} \end{array} \right] = \left[\begin{array}{c} \text{Counter} \\ \text{Resolution}^3 \\ (\pm 1 \text{ count}) \end{array} \right] + \left[\begin{array}{c} \text{Reference} \\ \text{Error} \\ (\text{INT or EXT}) \end{array} \right]$$

Internal Reference Error: See counter internal reference characteristics.

Fine Tuning: Unlocked > 1000 ppm total range.
Locked mode >±20 ppm by varying internal time base vernier.⁴

Stability:

	Normal	Locked ⁵
Time (after 2 h warm-up)	<10 ppm/10 min	<0.05 ppm/h
Temperature	<50 ppm/°C	<±2 ppm drift ⁶ from 15° to 35°C <±10 ppm drift ⁶ from 0° to 50°C
Line Voltage⁷ (+5% to -10% line voltage change)	<1 ppm	<0.1 ppm
Load (with any passive load change)	<1 ppm	No frequency variation measurable
Level Change (10 dB on output level vernier)	<1 ppm	
Mode Change (CW to FM)	1% of selected peak deviation or 200 Hz (400 Hz for Option 002) whichever is greater.	

Internal Counter Resolution (Unlocked):

Frequency Ranges (MHz)	Normal Mode	Expand X10	Expand X100
0.5 - 1	10 Hz	1 Hz	0.1 Hz
1 - 16	100 Hz	10 Hz	1 Hz
16 - 128	1 kHz	100 Hz	10 Hz
128 - 1024	10 kHz	1 kHz	100 Hz

Optimum Counter Resolution When Phase-Locked:

Frequency Ranges (MHz)	With 6 Digits	+ ½ Digit
0.5 - 0.9999995	1 Hz	0.5 Hz
1.0 - 9.999995	10 Hz	5 Hz
10.0 - 99.99995	100 Hz	50 Hz
100.0 - 999.9995	1 kHz	500 Hz
1000 - 1024	10 kHz	5 kHz

¹ 512- 1024 MHz can also be obtained using an external doubler Model 11690A.

² A seventh digit is used to increment the frequency, when locked, by ½ the least significant digit (displays a 5 only).

³ When phase locked, Counter Resolution error is eliminated.

⁴ Display is uncalibrated when varying the time base vernier. Uncal annunciator will light.

⁵ These specifications are given for the internal reference. When using an external reference, drift in the locked mode will depend on the external reference characteristics.

⁶ Phase lock may break due to temperature change (i.e., during warm-up). Simply relock at desired frequency.

⁷ This specification is for short term transient line changes.

Table 1-1. Specifications (2 of 7)

FREQUENCY (Cont'd)																										
Restabilization Time:																										
	Normal	Locked¹																								
After frequency change	<15 min.	<1 min. after relocking to be within 0.1 ppm of steady-state frequency.																								
After range change	None																									
SPECTRAL PURITY																										
Harmonics (at 1 volt, +10 dBm output range and below):		Residual AM (averaged rms):																								
0.5 to 512 MHz: >30 dB below carrier (dBc).		<table border="1" style="width: 100%; border-collapse: collapse;"> <thead> <tr> <th colspan="2" style="text-align: center;">Post-Detection Noise Bandwidth</th> </tr> </thead> <tbody> <tr> <td style="text-align: center;">300 Hz to 3 kHz</td> <td style="text-align: center;">20 Hz to 15 kHz</td> </tr> <tr> <td style="text-align: center;">>85 dBc</td> <td style="text-align: center;">>78 dBc</td> </tr> </tbody> </table>		Post-Detection Noise Bandwidth		300 Hz to 3 kHz	20 Hz to 15 kHz	>85 dBc	>78 dBc																	
Post-Detection Noise Bandwidth																										
300 Hz to 3 kHz	20 Hz to 15 kHz																									
>85 dBc	>78 dBc																									
512 to 1024 MHz (Option 002): >12 dBc.																										
Spurious Output Signals (excluding frequencies within 15 kHz of the signal whose effects are specified in residual AM and FM):																										
Frequency Range (MHz)	Subharmonically Related² (dBc)	Non-harmonically Related (dBc)																								
0.5 to 512	>100	>100																								
512 to 1024 (Option 002)	>20																									
Noise: [averaged rms noise level below carrier (dBc) stated in a 1 Hz bandwidth]: (Single Sideband)																										
Phase Noise at 20 kHz offset from carrier.																										
512 to 1024 MHz (Option 002): >124 dBc from 460 to 900 MHz increasing linearly to >116 dBc at 1100 MHz.																										
256 to 512 MHz: >130 dBc from 230 to 450 MHz increasing linearly to >122 dBc at 550 MHz.																										
0.5 to 256 MHz: Decreases approximately 6 dB for each divided frequency range until it reaches SSB Broadband Noise Floor of >140 dBc.																										
SSB Broadband Noise Floor at maximum output vernier and offset greater than 500 kHz from carrier:																										
512 to 1024 MHz (Option 002): >137 dBc.																										
0.5 to 512 MHz: >140 dBc.																										
		<table border="1" style="width: 100%; border-collapse: collapse;"> <thead> <tr> <th rowspan="3" style="text-align: center;">Frequency Range (MHz)</th> <th colspan="4" style="text-align: center;">Post-Detection Noise Bandwidth</th> </tr> <tr> <th colspan="2" style="text-align: center;">CW and up to 1/8 maximum allowable peak deviation</th> <th colspan="2" style="text-align: center;">Up to maximum allowable peak deviation</th> </tr> <tr> <th style="text-align: center;">300Hz to 3 kHz</th> <th style="text-align: center;">20 Hz to 15 kHz</th> <th style="text-align: center;">300 Hz to 3 kHz</th> <th style="text-align: center;">20 Hz to 15 kHz</th> </tr> </thead> <tbody> <tr> <td style="text-align: center;">256 to 512</td> <td style="text-align: center;"><5 Hz</td> <td style="text-align: center;"><15 Hz</td> <td style="text-align: center;"><15Hz</td> <td style="text-align: center;"><30Hz</td> </tr> <tr> <td style="text-align: center;">512 to 1024 (Option 002)</td> <td style="text-align: center;"><10Hz</td> <td style="text-align: center;"><30Hz</td> <td style="text-align: center;"><30Hz</td> <td style="text-align: center;"><60Hz</td> </tr> </tbody> </table>		Frequency Range (MHz)	Post-Detection Noise Bandwidth				CW and up to 1/8 maximum allowable peak deviation		Up to maximum allowable peak deviation		300Hz to 3 kHz	20 Hz to 15 kHz	300 Hz to 3 kHz	20 Hz to 15 kHz	256 to 512	<5 Hz	<15 Hz	<15Hz	<30Hz	512 to 1024 (Option 002)	<10Hz	<30Hz	<30Hz	<60Hz
Frequency Range (MHz)	Post-Detection Noise Bandwidth																									
	CW and up to 1/8 maximum allowable peak deviation		Up to maximum allowable peak deviation																							
	300Hz to 3 kHz	20 Hz to 15 kHz	300 Hz to 3 kHz	20 Hz to 15 kHz																						
256 to 512	<5 Hz	<15 Hz	<15Hz	<30Hz																						
512 to 1024 (Option 002)	<10Hz	<30Hz	<30Hz	<60Hz																						
<p>Note: Residual FM for ranges below 256–512 MHz decreases by approximately 1/4 for each divided frequency range until limited by the broadband noise floor. This limit for 300 Hz to 3 kHz bandwidth is ≈ 1 Hz and for 20 Hz to 15 kHz bandwidth is ≈ 4 Hz. In lock expand X10 mode, residual FM may increase approximately 2 Hz.</p>																										
<p>¹These specifications are given for the internal reference. When using an external reference, drift in the locked mode will depend on the external reference characteristics.</p> <p>²In the 512-1024 MHz range (Option 002), subharmonically related signals are 1/2F, (i.e., oscillator fundamental), 3/2F, 5/2F, etc.</p>																										

Table 1-1. Specifications (3 of 7)

OUTPUT

Range: 10 dB steps and 18 dB vernier provide the following output power settings into 50Ω.

Frequency Range (MHz)	Standard	Option Combination		
		002	003	002/003
0.5-512	+19 to -145 dBm (2V to 0.013 μV)	+18.5 to -145 dBm (1.9V to 0.013 μV)	+18.5 to -145 dBm (1.9V to 0.013 μV)	+18 to -145 dBm (1.8V to 0.013 μV)
512-1024 (Option 002)	-	+13 to -145 dBm (1V to 0.013 μV)	-	+12 to -145 dBm (0.9V to 0.013 μV)

Reverse Power Damage Level (without Reverse Power Protection, Option 003):

40 Vdc maximum or RF power level shown below:

Frequency Range (MHz)	Output Range			
	3V	1V	0.3V	All Others
0.5-512	100 mW (20 dBm)	100 mW (20 dBm)	500 mW (27 dBm)	500 mW (27 dBm)
512-1024 (Option 002)	20 mW (13 dBm)	20 mW (13 dBm)	200 mW (23 dBm)	500 mW (27 dBm)

Reverse Power Protection (Option 003): Protects Signal Generator from accidental application of up to 50W (+47 dBm) of RF power (between dc and 1100 MHz) into generator output.

Leakage (with all unused outputs terminated properly):

Leakage limits are below those specified in MIL-I-6181D. Furthermore, less than 3 μV is induced in a 2-turn, 25.4 mm (1 inch) diameter loop 25.4 mm (1 inch) away from any surface and measured into a 50Ω receiver. This permits receiver sensitivity measurements to at least <0.03 μV in a shielded system.

Auxiliary Output: Rear panel BNC output is >-5 dBm into 50Ω; source impedance is approximately 500Ω. This output is not doubled on the 512-1024 MHz range (Option 002).

Level Flatness (referred to output at 50 MHz and applies to 1V range and for top 10 dB of vernier range):

Frequency Range (MHz)	Standard	Option Combination		
		002	003	002/003
0.5-64	±0.5 dB	±0.5 dB	+0.75 dB	+1.0 dB
64-512		±1.0 dB	-1.25 dB	-2.0 dB
512-1024 (Option 002)	-	±1.5 dB	-	±2.0 dB

Table 1-1. Specifications (4 of 7)

OUTPUT (Cont'd)

Impedance: 50Ω, ac coupled, SWR less than:

Frequency Range (MHz)	Output Level Range	Standard SWR	Option Combination		
			002 SWR	003 SWR	002/003 SWR
0.5-512	3V and 1V	2.0	2.5	2.5	2.5
	0.3V and below	1.3	1.3	1.5	1.7
512-1024 (Option 002)	1V	-	2.5	-	2.5
	0.3V and below	-	1.5	-	1.7

Level Accuracy (total accuracy as indicated on Level Meter):¹

Frequency Range (MHz)	Output Level (dBm)			
	Using Top 10 dB of Vernier Range ²			With Reverse Power Protection (Option 003)
	+19 to -7	-7 to -47	-47 to -137	+18.5 to -137
0.5-512	±1.5 dB	±2.0 dB	±2.5 dB	Add +0.25 dB -0.75 dB

With Internal Doubler (Option 002):

Frequency Range (MHz)	Output Level (dBm)			
	Using Top 10 dB of Vernier Range ²			With Reverse Power Protection (Option 003)
	+18.5 to -7	-7 to -47	-47 to -137	+18 to -137
0.5-64	±1.5 dB	±2.0 dB	±2.5 dB	Add +0.5 dB -1.5 dB
64-512	±2.0 dB	±2.5 dB	±3.0 dB	Add +0.0 dB -1.0 dB
512-1024	±3.0 dB (+13 to -7 dBm)	±3.5 dB	±4.0 dB (-47 to -127 dBm)	Add ±0.5 dB (+12 to -128 dBm)

¹Level Accuracy error consists of allowances for: meter accuracy, detector linearity, flatness, attenuator accuracy, and twice the measurement error. All but the attenuator accuracy and the measurement error can be calibrated out with a power meter at a fixed setting. See HP Application Note 170-1.

²When below top 10 dB of Vernier Range, add ±0.5 dB.

Table 1-1. Specifications (5 of 7)

MODULATION

General

Types: Internal AM and FM.
External AM, FM, and PULSE.
Simultaneous AM and FM or PULSE and FM.

Optional (internal Variable Audio Oscillator Option 001):
Frequency: continuously variable from 0 Hz to 600 kHz $\pm 15\%$ in 5 decade ranges plus fixed 400 Hz and 1 kHz $\pm 3\%$.

Internal Modulation Sources (independently adjustable output is available at front panel):

Output Level: indicated 1 mV to 3V into 600 Ω .

Standard:

Frequency: fixed 400 Hz and 1 kHz $\pm 3\%$.
Output Level: indicated 10 mV to 1 V_{rms} into 600 Ω .

Total Harmonic Distortion:

- <0.5 % 400 Hz and 1 kHz fixed tones.
- <0.5 % 20 Hz to 2 kHz.
- <1.0 % 2 kHz to 200 kHz.
- <2.0 % 200 kHz to 600 kHz.

Amplitude Modulation

(AM specifications apply to the top 10 dB of output vernier range unless otherwise specified.)

Depth:

0.5 to 512 MHz: 0 to 100% for output levels of +13 dBm and below.¹
512 to 1024 MHz (Option 002): 0 to 100% for output levels of +7 dBm and below, excluding the top 6 dB of vernier range.²

External AM Sensitivity (400 Hz and 1 kHz rates):

0.5 to 512 MHz: (0.100 \pm 0.005)% AM per mV peak into 600 Ω with AM vernier at fully clockwise (cw) position.
512 to 1024 MHz (Option 002):
Nominal 0.1% AM per mV peak into 600 Ω with AM vernier at fully cw position.

AM Rates: Internal and External ac; 20 Hz to AM 3 dB bandwidth. External dc; dc to AM 3 dB bandwidth.

AM 3 dB Bandwidth:

Frequency Ranges (MHz)	0 to 50% AM	50 to 90% AM
0.5-2	20 kHz	12.5 kHz
2-8	40 kHz	25 kHz
8-512	60 kHz	50 kHz
512-1024 (Option 002)	60 kHz	50 kHz

Indicated AM Accuracy (400 Hz and 1 kHz rates using internal meter):

0.5 to 512 MHz: \pm (5.5% of reading +1.5% full scale) from 0 to 50 $^{\circ}$ C.
512 to 1024 MHz (Option 002):
Not specified; each generator can be individually calibrated using operating manual procedure.

AM Distortion (at 400 Hz and 1 kHz rates):

Frequency Range (MHz)	0 to 50% AM	50 to 90% AM
0.5-512	<1%	<3%
Frequency Range (MHz)	0 to 30% AM	30 to 90% AM
512-1024 (Option 002)	<10%	<20%

Peak Incidental Phase Modulation (at 30% AM):

0.5 to 128 MHz: <0.15 radians.
128 to 512 MHz: <0.3 radians.
512 to 1024 MHz (Option 002): <0.6 radians.

Peak Incidental Frequency Deviation: Equals peak incidental phase modulation \times modulation rate.

¹ AM is possible above +13 dBm as long as the peak envelope power (carrier output plus AM depth) does not exceed +19 dBm (+18.5 dBm with Option 003).

² AM is possible above +7 dBm as long as the peak envelope power (carrier output plus AM depth) does not exceed +13 dBm (+12 dBm with Option 002/003). Also, the peak envelope power (carrier plus AM depth) may not exceed the maximum level of any output level range. For example, if the output level control is set to the -20 dBm position (maximum output level is -17 dBm), the peak envelope power may not exceed -17 dBm. The REDUCE PEAK POWER annunciator lights when peak envelope power has been exceeded.

Table 1-1. Specifications (6 of 7)

MODULATION (Cont'd)						
Pulse Modulation						
(Specifications apply for top 10 dB of output vernier range)						
Frequency Ranges (MHz)	0.5 to 1	1 to 2	2 to 8	8 to 32	32 to 512	512 to 1024 (Option 002)
Rise and Fall Times	$< 9 \mu s$	$< 4 \mu s$	$< 2 \mu s$	$< 1 \mu s$		$< 1 \mu s$ typical
Pulse Repetition Rate	50 Hz to 50 kHz		50 Hz to 100 kHz	50 Hz to 250 kHz	50 Hz to 500 kHz	
Pulse Width Minimum for Level Accuracy Within 1 dB of CW ($> 0.1\%$ duty cycle)	$10 \mu s$		$5 \mu s$	$2 \mu s$		
Pulse ON/OFF Ratio at Maximum Vernier	> 40 dB					> 60 dB
Peak Input Required	Nominally $> +0.5V$ (5V max.) sinewave or pulse return to zero, into 50Ω .					

Frequency Modulation																									
<p>Deviation: Maximum allowable deviation equals 1% of lowest frequency in each range as shown below.</p> <table border="1" style="width: 100%; border-collapse: collapse;"> <thead> <tr> <th style="text-align: center;">Frequency Range (MHz)</th> <th style="text-align: center;">Maximum Peak Deviation (kHz)</th> </tr> </thead> <tbody> <tr><td style="text-align: center;">0.5 - 1</td><td style="text-align: center;">5</td></tr> <tr><td style="text-align: center;">1 - 2</td><td style="text-align: center;">10</td></tr> <tr><td style="text-align: center;">2 - 4</td><td style="text-align: center;">20</td></tr> <tr><td style="text-align: center;">4 - 8</td><td style="text-align: center;">40</td></tr> <tr><td style="text-align: center;">8 - 16</td><td style="text-align: center;">80</td></tr> <tr><td style="text-align: center;">16 - 32</td><td style="text-align: center;">160</td></tr> <tr><td style="text-align: center;">32 - 64</td><td style="text-align: center;">320</td></tr> <tr><td style="text-align: center;">64 - 128</td><td style="text-align: center;">640</td></tr> <tr><td style="text-align: center;">128 - 256</td><td style="text-align: center;">1280</td></tr> <tr><td style="text-align: center;">256 - 512</td><td style="text-align: center;">2560</td></tr> <tr><td style="text-align: center;">512 - 1024 (Option 002)</td><td style="text-align: center;">5120</td></tr> </tbody> </table>	Frequency Range (MHz)	Maximum Peak Deviation (kHz)	0.5 - 1	5	1 - 2	10	2 - 4	20	4 - 8	40	8 - 16	80	16 - 32	160	32 - 64	320	64 - 128	640	128 - 256	1280	256 - 512	2560	512 - 1024 (Option 002)	5120	<p>External FM Sensitivity: 1 volt peak into 600Ω yields maximum deviation indicated on PEAK DEVIATION switch with FM vernier at fully cw position.</p> <p>External FM Sensitivity Accuracy (400 Hz and 1 kHz rates from 15° to $35^\circ C$): Excluding maximum peak deviation position: $\pm 6\%$. Maximum peak deviation position: $\pm 9\%$ typically.</p> <p>Indicated FM Accuracy (400 Hz and 1 kHz rates from 15° to $35^\circ C$, using internal meter): Excluding maximum peak deviation position: $\pm (7\%$ of reading $+1.5\%$ full scale). Maximum peak deviation position: $\pm (10\%$ of reading $+1.5\%$ full scale), typically.</p> <p>Incidental AM (at 400 Hz and 1 kHz rates): 0.5 to 512 MHz: $< 0.5\%$ AM for FM deviations up to 1/8 maximum allowable. $< 1.0\%$ AM for FM deviations up to maximum allowable.</p> <p>512 to 1024 MHz (Option 002): $< 1.0\%$ AM for FM deviations up to 1/8 maximum allowable. $< 7\%$ AM for FM deviations up to maximum allowable.</p>
Frequency Range (MHz)	Maximum Peak Deviation (kHz)																								
0.5 - 1	5																								
1 - 2	10																								
2 - 4	20																								
4 - 8	40																								
8 - 16	80																								
16 - 32	160																								
32 - 64	320																								
64 - 128	640																								
128 - 256	1280																								
256 - 512	2560																								
512 - 1024 (Option 002)	5120																								

FM 3 dB Bandwidth:¹
 Internal and External ac; 20 Hz to 250 kHz.
 External dc; dc to 250 kHz.

FM Distortion (at 400 Hz and 1 kHz rates):
 $< 1\%$ for deviations up to 1/8 maximum allowable.
 $< 3\%$ for deviations up to maximum allowable.

¹When in locked mode, FM is possible only for rates greater than 50 Hz.

Table 1-1. Specifications (7 of 7)

COUNTER

External RF Input:

Frequency Range: 1 Hz to 550 MHz.
Sensitivity: ≥ 100 mVrms, ac only, into 50Ω (≥ -7 dBm).
Input level may not exceed +15 dBm (1.3 Vrms).

External Count Resolution: 6-digit LED display.

MODE (MHz)	Normal	Expand X10	Expand X100
0 - 10	100 Hz	10 Hz	1 Hz
10 - 550	10 kHz	1 kHz	100 Hz

Internal Reference (after 2 h warm-up and calibration at 25°C):

Aging Rate:
 < 0.05 ppm/h; < 2 ppm/90 days.
Temperature Drift:
 $< \pm 2$ ppm from 15° to 35°C.
 $< \pm 10$ ppm from 0° to 50°C.
Line Voltage Variations:
 < 0.1 ppm for +5% to -10% line voltage change.
Typical Overall Accuracy (within 3 months calibration and from 15° to 35°C): ± 2 ppm.

Frequency Tuning: typically $> \pm 20$ ppm using internal time base vernier.

External Reference Input: 5 MHz, nominally $> 0.5V$ peak-to-peak (5V maximum) into 1000Ω .

Rear Output: nominally $> 0.5V$ peak-to-peak into 500Ω . This will drive another 8640B.

GENERAL

Operating Temperature Range: 0° to 55°C.

Power Requirements: 100 or 120 volts (+5%, -10%) from 48 to 440 Hz; or 220 or 240 volts (+5%, -10%) from 48 to 66 Hz. 175 VA max (Option 002:190 VA max). 2.3 m (7.5 ft) power cable furnished with mains plug to match destination requirements.

Weight:

Net 20.8 kg (45 lb 14 oz).

Dimensions:¹

- NOTES:
Dimensions in millimetres and (inches)
- Ⓐ EIA rack height (including filler strip). For cabinet height (including feet) add 8 (0.32) to EIA rack height
 - Ⓑ Rear apron recess

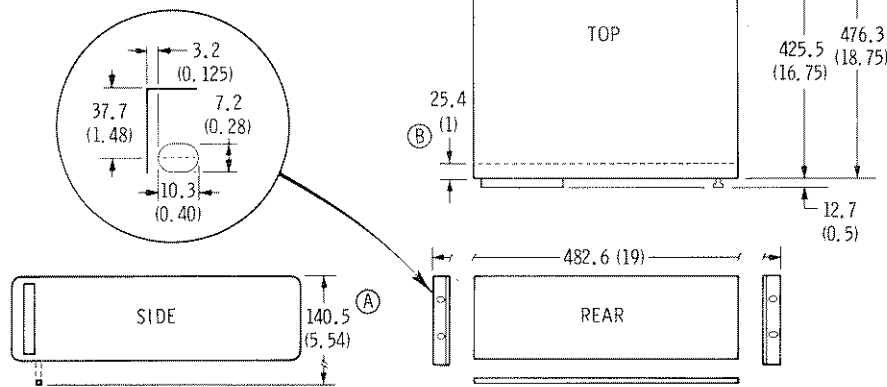

¹Dimensions are for general information only. If dimensions are required for building special enclosures, contact your HP office. Dimensions for Option 908 Rack Flange Kit are also shown.

Table 1-2. Recommended Test Equipment (1 of 4)

Instrument Type	Critical Specifications	Suggested Model	Use*
20 dB Amplifier (2 required)	Range: 0.5–520 MHz Gain: 20 to 25 dB Flatness over Range: ± 2 dB Impedance: 50Ω Noise Figure: < 5 dB	HP 8447A	P
20 dB Amplifier (2 required for Opt. 002 only, otherwise one required)	Range: 0.4– 1200 MHz Gain: > 20 dB Flatness: ± 2 dB Impedance: 50Ω Noise Figure: < 5 dB to 1 GHz	HP 8447B	P
40 dB Amplifier	Range: 5 Hz to 100 kHz Gain: 20 and 40 dB ± 1 dB Input Impedance: $> 5k\Omega$ Output Impedance: 50Ω Noise: $< 25 \mu V_{rms}$ referred to input Output: $> 1 V_{rms}$ into 50Ω	HP 465A	P, A
40 dB Amplifier	Range: 20 Hz to 100 kHz Gain: 40 ± 1 dB Input Impedance: 50Ω Noise Figure: < 3 dB when driven from 50Ω Output Level: > 100 mV in 50Ω	HP 08640–60506	P
25.4 mm (1 inch) Loop Antenna	To ensure measurement accuracy, no substitution is possible. Fabrication depends upon machining and assembling to close tolerances.	HP 08640–60501	P
10 dB Step Attenuator	Attenuation: 0– 90 dB in 10 dB steps Range: 0.45–1 GHz Accuracy: ± 1.5 dB to 90 dB	HP 355D	P, A
10 dB Attenuator (required for Opt. 003 only)	Accuracy: ± 0.5 dB to 1.2 GHz	HP 8491A Opt 010	A
Crystal Detector	Range: 0.45– 1200 MHz Low Level Sensitivity: > 0.35 mV/ μW No internal dc return	HP 8471A	P, A
Digital Multimeter	DC Accuracy: $\pm (0.01\%$ of reading $+ 0.02\%$ of range) AC Accuracy: $\pm 0.1\%$ of reading Ohms Range: to 1 k Ω	HP 3490A	P, A, T
*P = Performance; A = Adjustments; T = Troubleshooting			

Table 1-2. Recommended Test Equipment (2 of 4)

Instrument Type	Critical Specifications	Suggested Model	Use*
Distortion Analyzer	Range: 20 Hz to 600 kHz Distortion Range: <0.1% Minimum Input: <300 mVrms	HP 331A	P
15 kHz Low-Pass Filter	15 kHz low-pass (7 pole) Impedance: 50Ω Ripple: <±0.2 dB	CIR-Q-TEL FLT/21B-15K- 7/50-3A/3B **	P
Frequency Counter	Range: to 550 MHz Input Sensitivity: <100 mV Inputs: 50Ω and high impedance (1 MΩ) Accuracy: <1 ppm Period and Frequency Measurement Capability Time Base: 10 MHz	HP 5327C	P,A,T
Frequency Meter	Ranges: 100 kHz to 10 MHz Linearity: <0.05% Analog Output: 1V for full scale	HP 5210A	P, A
Filter Kit	Output Low-Pass Filters for Frequency Meter (20 kHz and 1 MHz Butterworth filters)	HP 10531A	
Frequency Standard	Frequency: 10 MHz, 5 MHz, 1 MHz, or 100 kHz Accuracy: <10 ⁻⁷ (preferred)	Suitable House Standard	A
FM Linearity Circuit (see para. 5-41 for possible requirement.)	See Figure 1-9	HP 08640-60503	A
Mixer	Double Balanced Range: 0.45-550 MHz	HP 10514A	P, A
Noise Phase Lock Circuit	See Figure 1-10	HP 08640-60504	P
Oscilloscope	50 MHz Real Time Sensitivity: 5 mV/division Internal/External Sweep and Triggering	HP 180C/1801A/ 1820C	P, A, T
Power Meter	Accuracy: ±1% of reading Range: 0.45-1200 MHz	HP 435A	P, A, T
Power Sensor	Input Level: -20 to +20 dBm VSWR: <1.2:1	HP 8482A	
Pulse Generator	Range: 50 Hz to 500 kHz Output: >1V into 50Ω Pulse Width: down to 1 μs Transition Time: <50 ns	HP 8003A	P, A, T
<p>*P = Performance; A = Adjustment; T = Troubleshooting **CIR-Q-TEL INC./10504 Wheatley/Kensington, MD 20795/Phone 301-946-1800.</p>			

Table 1-2. Recommended Test Equipment (3 of 4)

Instrument Type	Critical Specifications	Suggested Model	Use*
RMS Voltmeter	Range: 10 Hz to 100 kHz Reading: True rms (ac only) Voltage Range: 1 mV to 10V full scale Accuracy: 1% of full scale 50 Hz to 50 kHz Scale: Voltage and dB	HP 3400A	P
Signal Generator	Range: 0.45–550 MHz Output: > 13 dBm into 50Ω Drift: < 20 ppm/10 min. SSB Phase Noise: > 130 dB down from 230 to 450 MHz increasing linearly to > 122 dB down at 550 MHz (stated in a 1 Hz bandwidth at 20 kHz offset from carrier) and decreasing approximately 6 dB/octave for each divided down range – but need not be less than 140 dB down. Residual FM: < 15 Hz rms in 20 Hz to 15 kHz post-detection noise bandwidth. Aux RF Out: > -5 dBm. Leakage: < 3 μV induced in a 2–turn, 1–inch diameter loop 1 inch away from any surface and measured into a 50Ω receiver. FM: dc coupled; at least 40 kHz deviation for 1V input.	HP 8640A	P, A
Audio Spectrum Analyzer	Range: 20–200 kHz Amplitude Calibration: Display Accuracy: ± 0.25 dB/dB but not more than 1.5 dB over 70 dB dynamic range. Flatness: ± 0.2 dB Vertical Reference Scale: 10 dB/division log, 2 dB/division (or less) log, and linear display calibration. Average Noise Level: < - 120 dBm (50Ω) with 1 kHz IF bandwidth. Spurious Responses: > -60 dB down for nominal specified inputs. Tracking Generator: Flatness: ± 0.25 dB Level: > 3 Vrms into 600Ω	HP 8556A/8552B/141T	P, A
RF Spectrum Analyzer (cont'd on next page)	Range: 0.5– 1250 MHz Amplitude Calibration: Display Accuracy: ± 0.25 dB/dB but not more than 1.5 dB over 70 dB dynamic range. Flatness: ± 1 dB IF Gain Step Accuracy: ± 0.2 dB	HP 8554B/8552B/141T	P, A, T
*P = Performance; A = Adjustments; T = Troubleshooting			

Table 1-2. Recommended Test Equipment (4 of 4)

Instrument Type	Critical Specifications	Suggested Model	Use*
RF Spectrum Analyzer (Continued)	Amplitude Calibration (continued): Vertical Reference Scale: 10 dB/division log, 2 dB/division (or less) log, and linear display calibration. Average Noise Level: < -102 dBm with 10 kHz IF bandwidth Spurious Responses: >60 dB down for inputs of -40 dBm or less Span Width: 0-1 GHz Compatible with Tracking Generator		
Test Oscillator	Range: 10 Hz to 10 MHz Output Impedance: 600Ω and 50Ω Distortion: >40 dB down Output Level: >3 Vrms	HP 651B	P, A, T
Test Oscillator (required for Opt. 003 only)	Frequency: 600 kHz Output Impedance: 600Ω Output: >10 Vrms into 600Ω	HP 200CD	T
Tracking Generator	Output: to 0 dBm (50Ω) Flatness: ±0.5 dB Compatible with Spectrum Analyzer (HP 8554B/8552B/141T)	HP 8444A	A
Variable Phase Oscillator (see para. 5-41 for pos- sible requirement)	Frequency: 1 kHz Level: >1V into 600Ω Phase Variability: 0 to 360°	HP 203A	A
VSWR Bridge (required for Opt. 003 only)	Range: 0.45-1200 MHz Directivity: >40 dB Connectors: Type N	Wiltron Model 60N50**	A
<p style="text-align: center;">*P = Performance; A = Adjustments; T = Troubleshooting **Wiltron Company /930 E. Meadow Drive/Palo Alto, CA 94303/TWX 9103731156/Phone 415-494-6666</p>			

Table 1-3. Recommended Test Accessories

Accessory Type	Suggested Model
Adapter (Type N Male and BNC Female connectors)	HP 1250-0067
Adapter (BNC Male and dual Banana post connectors)	HP 10110A
Adapter (two SMC Male connectors)	HP 1250-0827
Adapter (Type N Male to GR 874)	HP 1250-0847
Extender Board (30 pins)	HP 5060-0049
Extender Board (20 pins)	HP 5060-0256
Extender Board (12 pins)	HP 5060-0257
Bumpers (4) for Extender Boards	HP 0403-0115
Double Shielded Cable (BNC Male connectors, coaxial)	HP 08708-6033
Nine-inch Cable (BNC Male connectors, coaxial)	HP 10502A
Test Cable (48-inch, BNC Male connectors, coaxial)	HP 10503A
Test Cable (SMC Male and BNC Male connectors)	HP 11592-60001
Cable Assembly (required for Opt. 002 only)	HP 10020-61601
Blocking Capacitor (required for Opt. 002 only)	HP 10217A
Ground Clip (required for Opt. 002 only)	HP 10213-62102
Divider 10:1 (required for Opt. 002 only)	HP 10020-67703
600 Ohm Feedthrough	HP 11095A
50 Ohm Load (Male, BNC, coaxial)	HP 11593A
50 Ohm Load (Male Type N)	HP 908A
Voltage Divider Probe (10:1) (2 preferred)	HP 10004D
1 Ω Resistor	HP 0757-0280
100 Ω Resistor	HP 0757-0401
Coaxial Short (Male Type N) (required for Opt. 003 only)	HP 11512A
Tee (Coaxial, BNC, one Male and two Female connectors)	HP 1250-0781

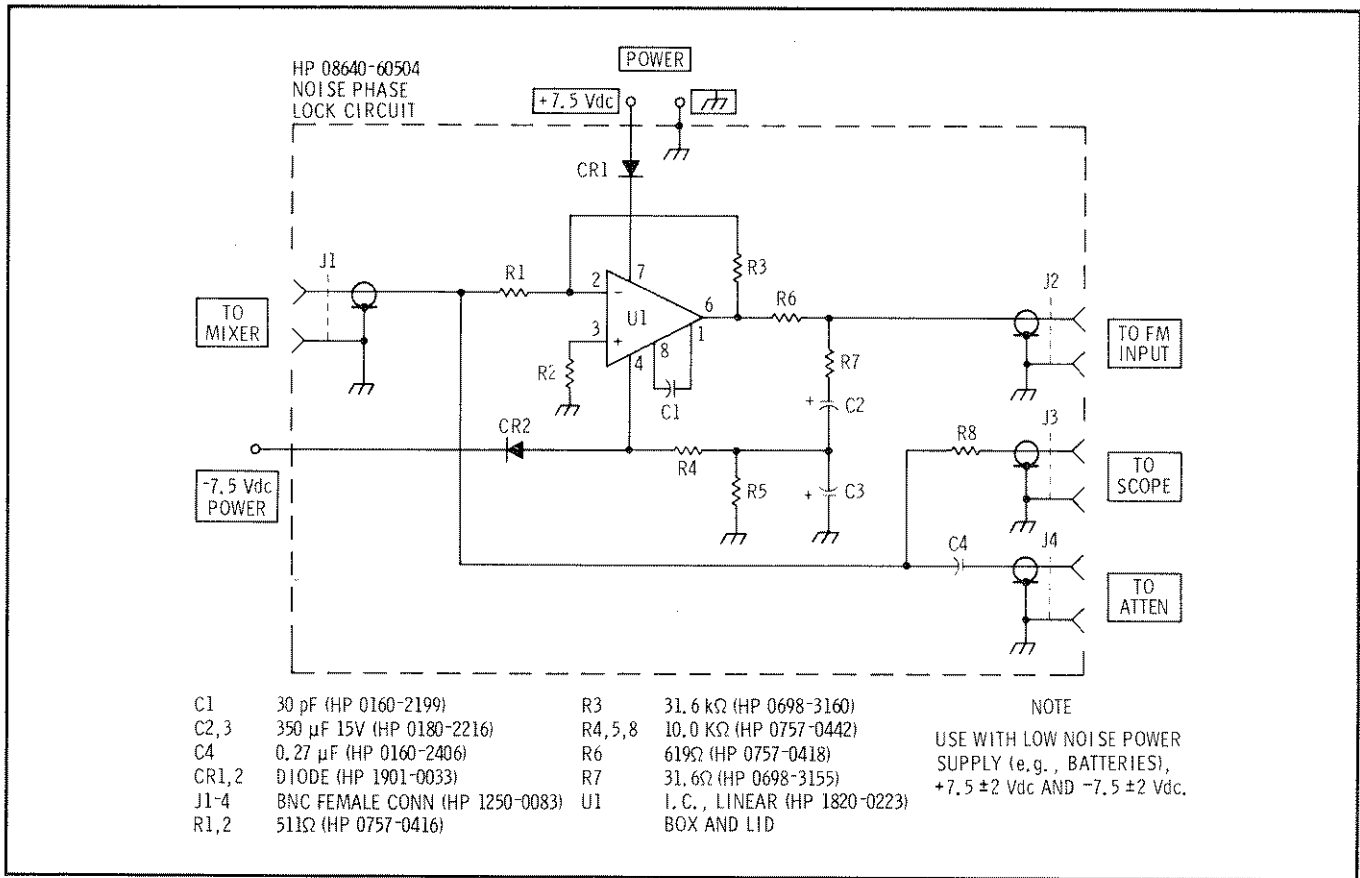

Figure 1-9. Noise Phase Lock Circuit

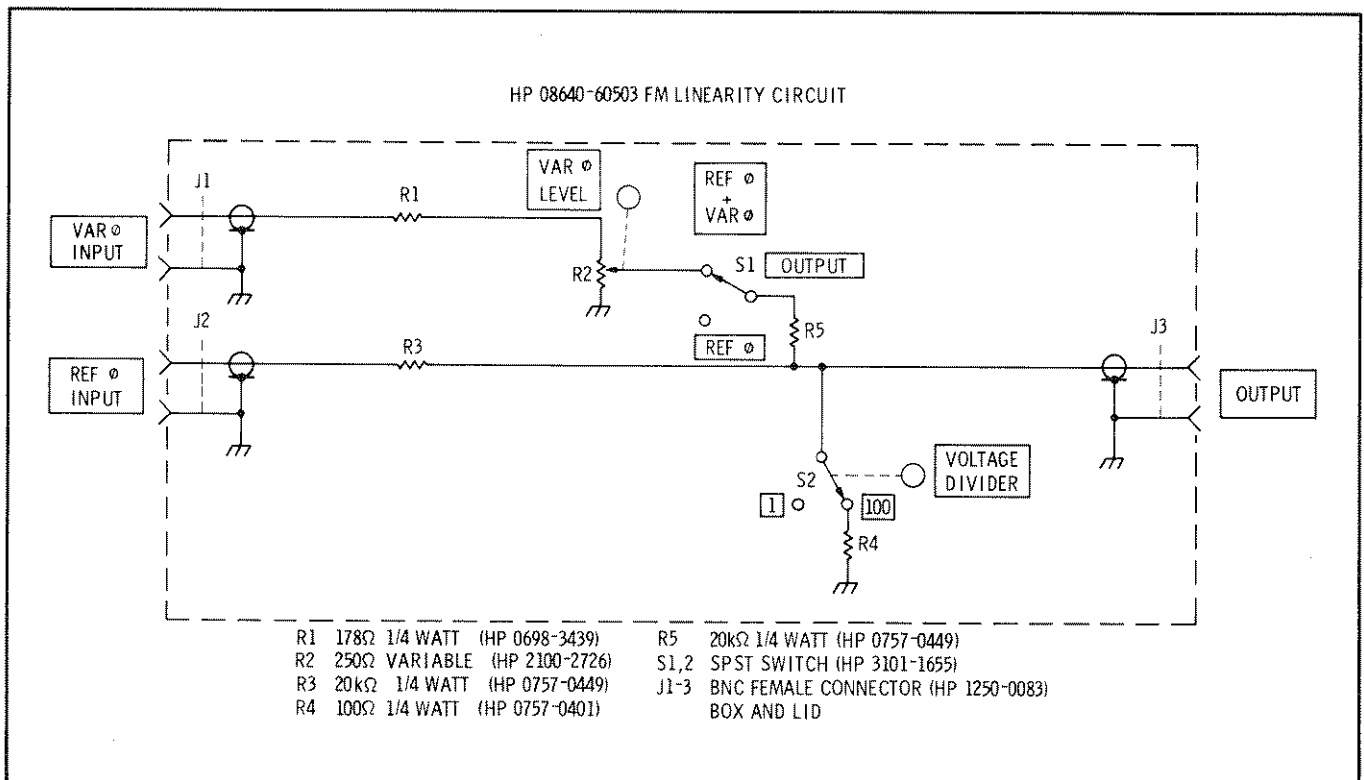

Figure 1-10. FM Linearity Circuit

(

(

(

SECTION II INSTALLATION

2-1. INTRODUCTION

2-2. This section explains how to prepare the Model 8640B Signal Generator for use. It explains how to connect the instrument to accept available line voltage, and it also describes bench operation, rack mounting, storage, and shipment.

2-3. INITIAL INSPECTION

2-4. Inspect the shipping container for damage. If the shipping container or cushioning material is damaged it should be kept until the contents of the shipment have been checked for completeness and the instrument has been checked mechanically and electrically. The contents of the shipment should be as shown in Figure 1-1, and procedures for checking electrical performance are given in Section IV. If the contents are incomplete, if there

is mechanical damage or defect, or if the instrument does not pass the electrical performance test, notify the nearest Hewlett-Packard office. If the shipping container is damaged, or the cushioning material shows signs of stress, notify the carrier as well as the Hewlett-Packard office. Keep the shipping materials for carrier's inspection. The HP office will arrange for repair or replacement of the instrument without waiting for claim settlement.

2-5. PREPARATION FOR USE

2-6. Power Requirements

2-7. The Model 8640B requires a power source of 100 or 120 volts (+5%, -10%) from 48 to 440 Hz; or 220 or 240 volts (+5%, -10%) from 48 to 66 Hz, single phase. Power consumption is 175VA max.

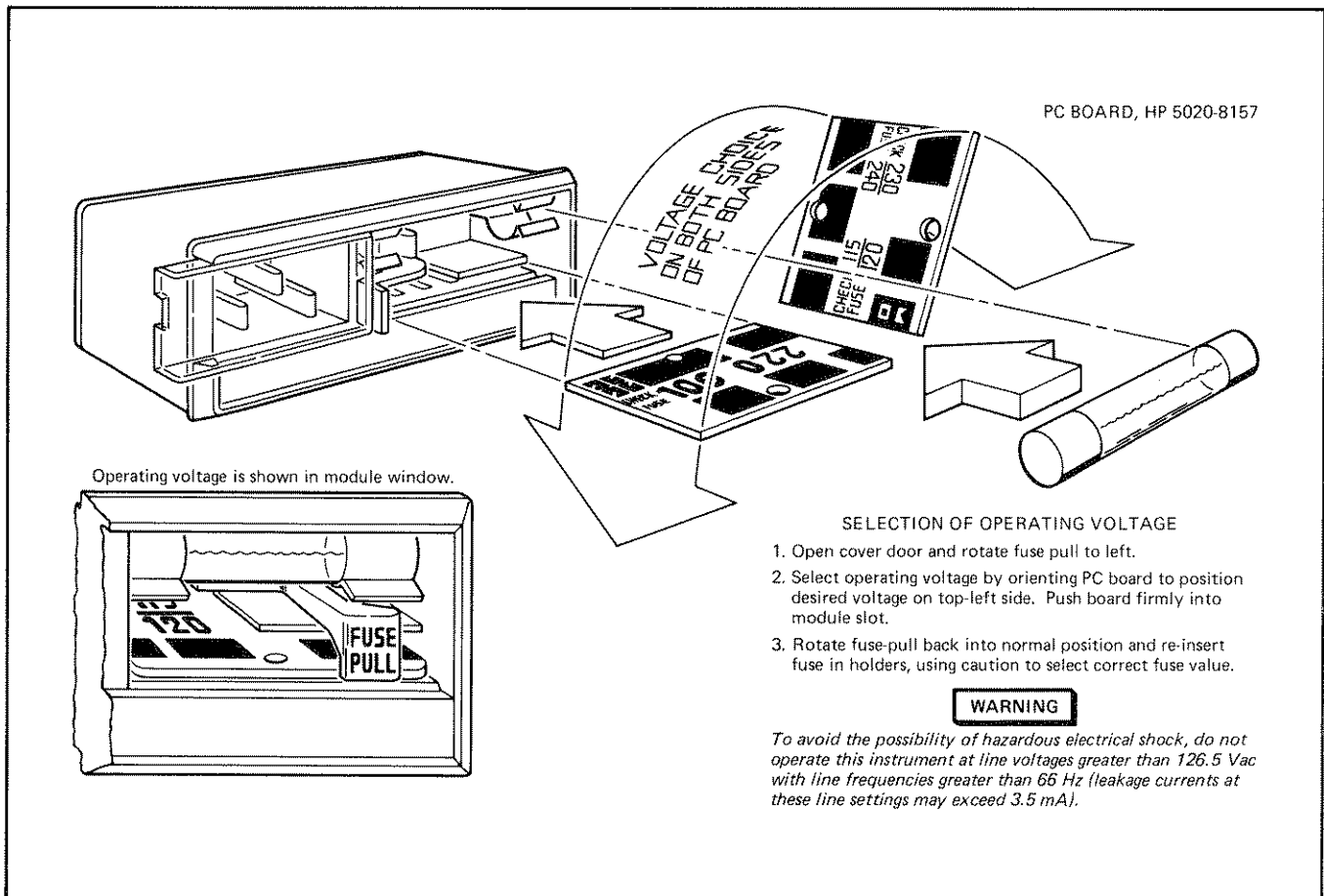

Figure 2-1. Line Voltage Selection

⚠ 2-8. Line Voltage Selection

CAUTION

To prevent damage to the instrument, make the line voltage and fuse selection BEFORE connecting the line power. Also ensure the line power cord is connected to a line power socket that is provided with a protective earth contact.

2-9. A rear panel, line power module permits operation from 100, 120, 220, or 240 Vac. The number visible in the window (located on the module) indicates the nominal line voltage to which the instrument must be connected.

2-10. To prepare the instrument for operation, slide the fuse compartment cover to the left (the line power cable must be disconnected). Pull the handle marked FUSE PULL and remove the fuse; rotate the handle to the left. Gently pull the printed circuit voltage selector card from its slot and orient it so that the desired operating voltage appears on the top-left side (see Figure 2-1).

Firmly push the voltage selector card back into its slot. Rotate the FUSE PULL handle to the right, install a fuse of the correct rating, and slide the fuse compartment cover to the right. A complete set of fuses is supplied with the instrument — see ACCESSORIES SUPPLIED in Section I.

NOTE

The correct fuse rating for the line voltage selected is listed on the line power module. More information about fuses is given in the table of replaceable parts in Section VI (reference designation is F1).

2-11. Power Cable

2-12. In accordance with international safety standards, this instrument is equipped with a three-wire power cable. When connected to an appropriate power line outlet, this cable grounds the instrument cabinet. The type of power cable plug shipped with each instrument depends on the country of destination. Refer to Figure 2-2 for the part numbers of the power cable plugs available.

 250V OPERATION PLUG*: SEV 1011.1959-24507 TYPE 12 CABLE*: HP 8120-2104	 250V OPERATION PLUG*: NZSS 198/AS C112 CABLE*: HP 8120-1369	 125V OPERATION PLUG*: NEMA 5-15P CABLE*: 8120-1378	 250V OPERATION PLUG*: NEMA G-15P CABLE*: HP 8120-0698
 250V OPERATION PLUG*: CEE7-VII CABLE*: HP 8120-1689	 250V OPERATION PLUG*: CEE22-V1 CABLE*: HP 8120-1860	 250V OPERATION PLUG*: BS 1363A CABLE: HP 8120-1351	
*The number shown for the plug is the industry identifier for the plug only. The number shown for the cable is an HP part number for a complete cable including the plug.			

Figure 2-2. Power Cables Available

Power Cable (Cont'd)

WARNING

To avoid the possibility of personal injury, the following precautions must be followed before the instrument is switched on:

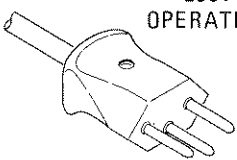
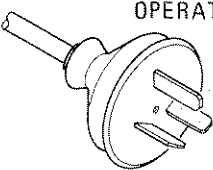
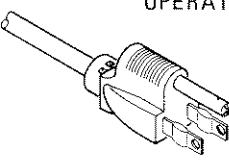
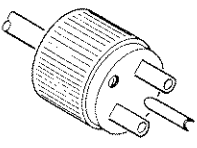
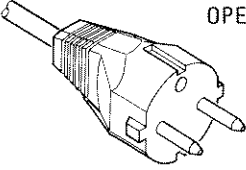
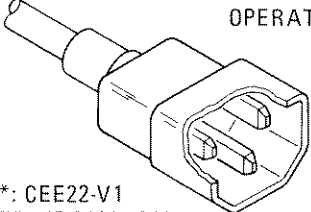
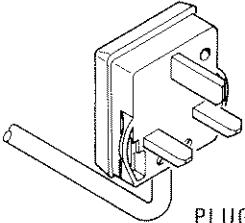
- a. If this instrument is to be energized via an autotransformer, make sure that the common terminal is connected to the earth grounded pole of the power source.*
- b. The power cable plug shall only be inserted into a socket outlet provided with a protective earth contact. The protective action must not be negated by the use of an extension cord without a protective conductor (grounding).*
- c. Before switching on the instrument, the protective earth terminal of the instrument must be connected to a protective conductor of the power cord. this is accomplished by ensuring that the instrument's internal earth terminal is correctly connected to the instrument's chassis and that the power cord is wired correctly (see Service Sheet 22).*

2-13. Mating Connectors

2-14. Mating connectors used with the Model 8640B should be either 50 ohm-type BNC male or Type N male connectors that are compatible with US MIL-C-39012.

2-15. Operating Environment

2-16. The operating environment should be within the following limitations:

Temperature 0°C to +55°C
 Humidity < 95% relative
 Altitude < 4600 metres (15 000 feet)

2-17. A forced-air cooling system is used to maintain the operating temperature required within the instrument. The air intake and filter are located on the rear panel, and warm air is exhausted through perforations in the right-hand side panel. When operating the instrument, choose a location that provides at least three inches of clearance at the rear and two inches clearance at the right side.

The clearances provided by the plastic feet in bench stacking and the filler strips in rack mounting are adequate for the top and bottom cabinet surfaces.

2-18. Bench Operation

2-19. The instrument cabinet has plastic feet and a foldaway tilt stand for convenience in bench operation. The tilt stand raises the front of the instrument for easier viewing of the control panel, and the plastic feet are shaped to make full-width modular instruments self-aligning when stacked.

2-20. Rack Mounting

2-21. A rack mounting kit is available (HP 5060-8740). This kit contains all the necessary hardware and installation instructions for mounting the instrument on a rack with 482.5 mm (standard 19 inch) spacing (see Figure 2-3).

2-22. STORAGE AND SHIPMENT

2-23. Environment

2-24. The instrument should be stored in a clean, dry environment. The following environmental limitations apply to both storage and shipment:

Temperature -40°C to +75°C
 Humidity < 95% relative
 Altitude < 7600 metres (25 000 feet)

2-25. Packaging

2-26. Original Packaging. Containers and materials identical to those used in factory packaging are available through Hewlett-Packard offices. If the instrument is being returned to Hewlett-Packard for servicing, attach a tag indicating the type of service required, return address, model number, and full serial number. Also, mark the container FRAGILE to assure careful handling. In any correspondence, refer to the instrument by model number and full serial number.

2-27. Other Packaging. The following general instructions should be used for re-packaging with commercially available materials:

- a. Wrap the instrument in heavy paper or plastic. (If shipping to a Hewlett-Packard office or service center, attach a tag indicating the type of service required, return address, model number, and full serial number.

Packaging (Cont'd)

b. Use a strong shipping container. A double-wall carton made of 2.4 MPa (350 psi) test material is adequate.

c. Use enough shock-absorbing material (75–100 mm layer) around all sides of the instrument to provide a firm cushion and prevent move-

ment inside the container. Protect the control panel with cardboard.

d. Seal the shipping container securely.

e. Mark the shipping container **FRAGILE** to assure careful handling.

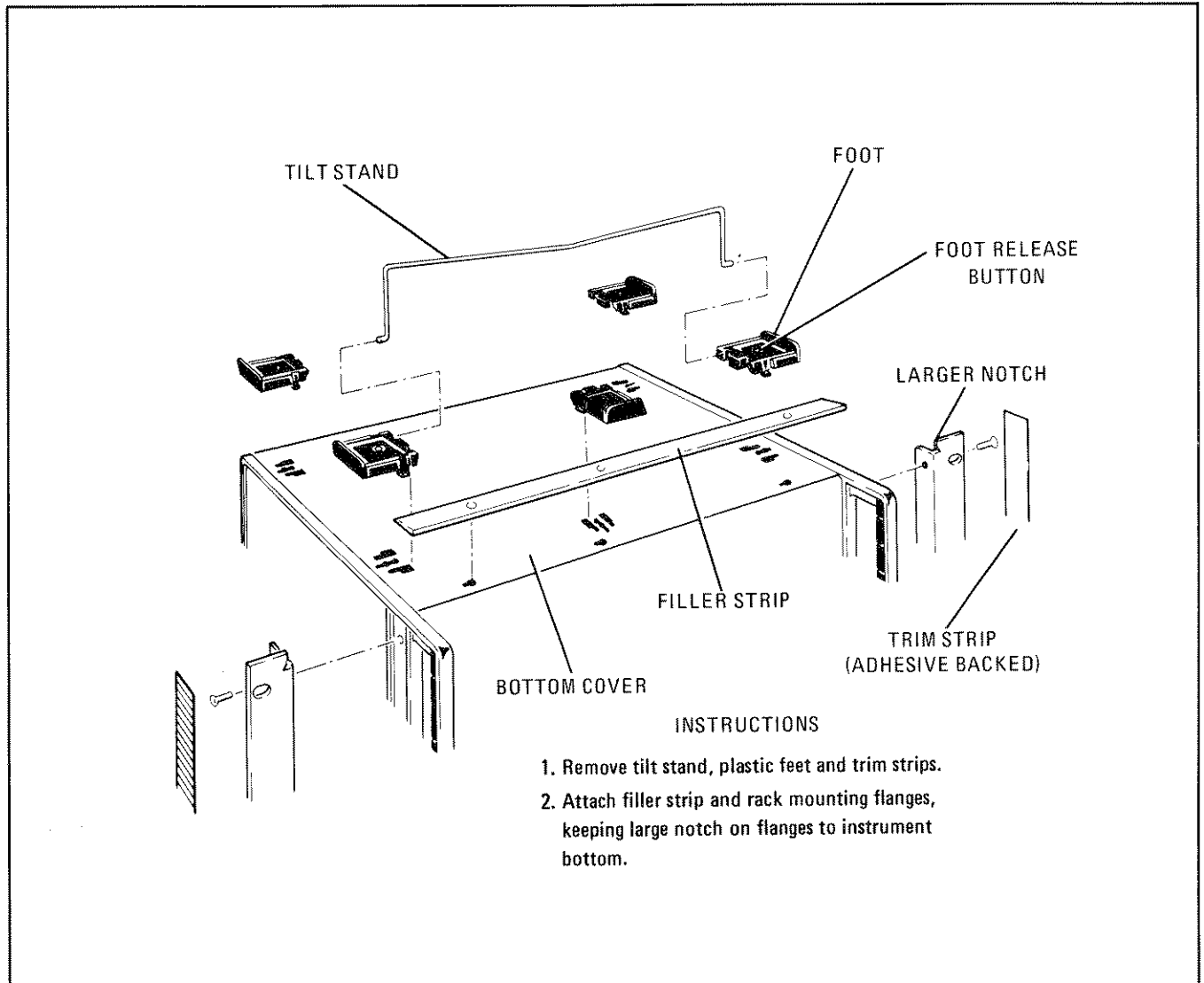

Figure 2-3. Preparation for Rack Mounting

SECTION III OPERATION

3-1. INTRODUCTION

3-2. This section describes the functions of the controls and indicators of the Model 8640B Signal Generator. It explains how to set the frequency, amplitude, and modulation controls, and covers such operator maintenance as fuse and indicator lamp replacement and fan filter cleaning.

WARNINGS

Before switching on the instrument, the protective earth terminals of the instrument must be connected to the protective conductor of the (mains) power cord. The mains plug shall only be inserted in a socket outlet provided with a protective earth contact. The protective action must not be negated by the use of an extension cord (power cable) without a protective conductor (grounding). Grounding one conductor of a two conductor outlet is not sufficient protection.

Ensure that all devices connected to this instrument are connected to the protective (earth) ground.

Make sure that only fuses with the required rated current and of the specified type (normal blow, time delay, etc.) are used for replacement. The use of repaired fuses and the short-circuiting of fuse holders must be avoided.

CAUTION

Before switching on this instrument, make sure it is set to the proper line voltage.

3-3. PANEL FEATURES

3-4. Front panel controls, indicators, and connectors are shown and described in Figure 3-2. Rear panel controls and connectors are shown and described in Figure 3-3.

3-5. OPERATOR'S CHECKS

3-6. Use the operator's checks in Figure 3-4 to verify proper operation of the Signal Generator's main functions.

3-7. OPERATING INSTRUCTIONS

3-8. Figures 3-5 and 3-6 explain how to set the frequency, amplitude, and modulation controls. Figure 3-5 also explains how to use the frequency counter and phase lock controls.

3-9. OPERATOR'S MAINTENANCE

3-10. **Fuse.** The main ac line fuse is located on the rear panel next to the line power cable jack. To remove the fuse, first remove the line power cable from its jack. Slide the fuse compartment cover to the left, then pull the handle marked FUSE PULL and remove the fuse.

WARNING

Make sure that only fuses with the required rated current and of the specified type (normal blow, time delay, etc.) are used for replacement. The use of repaired fuses and the short-circuiting of fuse-holders must be avoided.

3-11. **Lamp Replacement.** Figure 3-1 explains how to replace the lamp located in the line power switch.

3-12. **Fan.** The cooling fan's filter is located on the rear panel. To service the filter, use a No. 2 Pozidriv screwdriver (HP 8710-0900) to remove the four screws that hold the filter to the rear panel. Then clean it, using a solution of warm

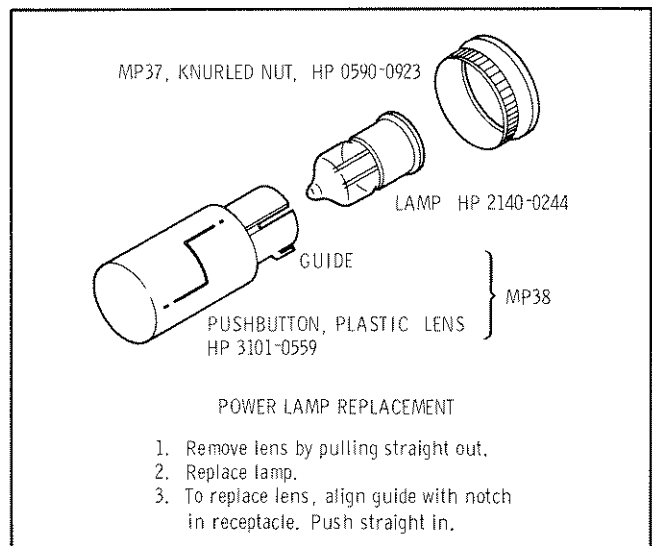
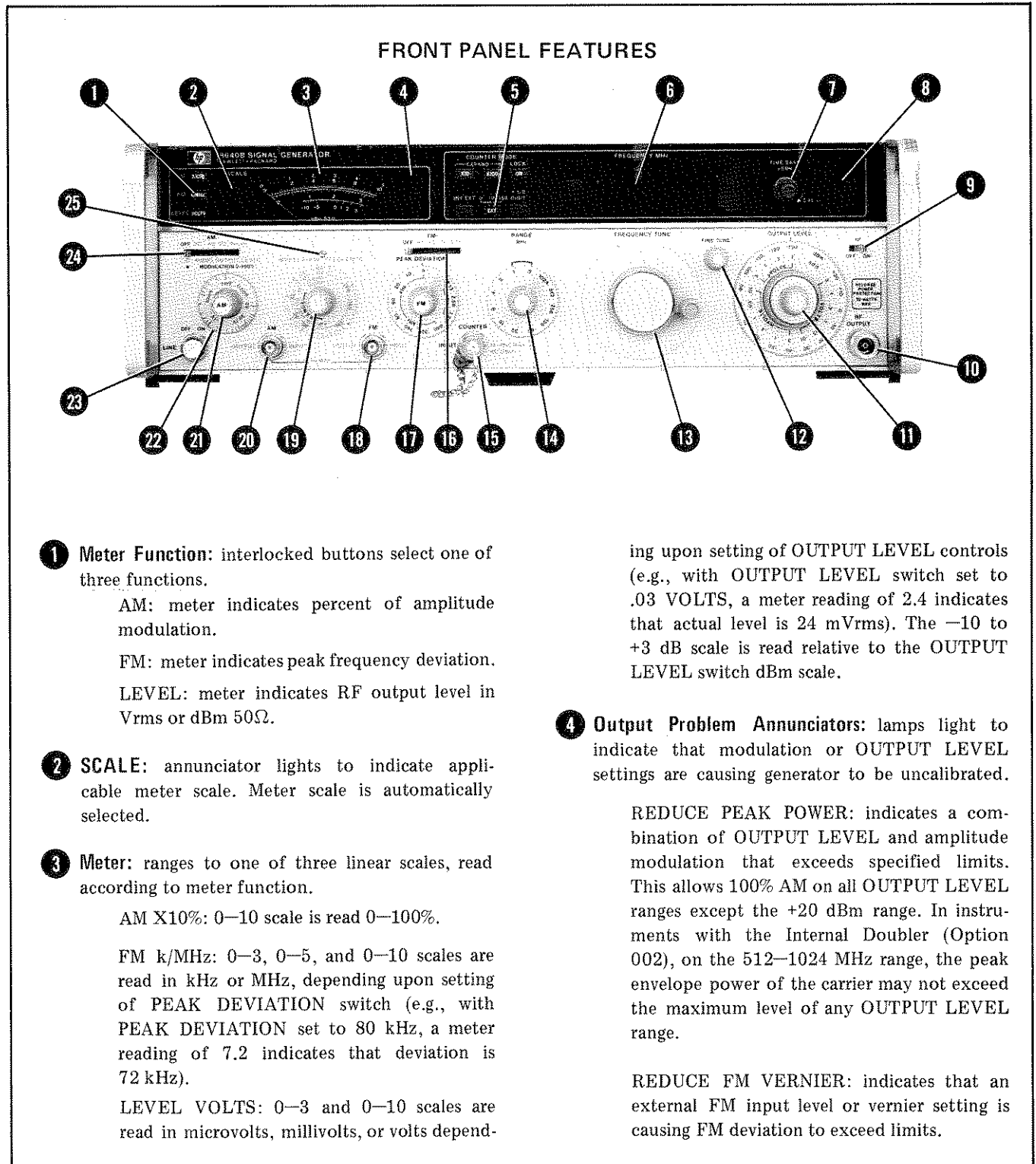

Figure 3-1. Lamp Replacement

water and soap, or replace it, using the part number listed in the table of replaceable parts in Section VI.

3-13. The fan motor has factory lubricated, sealed bearings and requires no periodic maintenance.

3-14. **Meter Zeroing.** To mechanically zero the front panel meter, set LINE switch to OFF and place instrument in its normal operating position. Turn adjustment screw cw until indicator indicates zero, then turn adjustment slightly ccw to free mechanism from adjusting peg.



1 Meter Function: interlocked buttons select one of three functions.

AM: meter indicates percent of amplitude modulation.

FM: meter indicates peak frequency deviation.

LEVEL: meter indicates RF output level in Vrms or dBm 50Ω.

2 SCALE: annunciator lights to indicate applicable meter scale. Meter scale is automatically selected.

3 Meter: ranges to one of three linear scales, read according to meter function.

AM X10%: 0-10 scale is read 0-100%.

FM k/MHz: 0-3, 0-5, and 0-10 scales are read in kHz or MHz, depending upon setting of PEAK DEVIATION switch (e.g., with PEAK DEVIATION set to 80 kHz, a meter reading of 7.2 indicates that deviation is 72 kHz).

LEVEL VOLTS: 0-3 and 0-10 scales are read in microvolts, millivolts, or volts depend-

ing upon setting of OUTPUT LEVEL controls (e.g., with OUTPUT LEVEL switch set to .03 VOLTS, a meter reading of 2.4 indicates that actual level is 24 mVrms). The -10 to +3 dB scale is read relative to the OUTPUT LEVEL switch dBm scale.

4 Output Problem Annunciators: lamps light to indicate that modulation or OUTPUT LEVEL settings are causing generator to be uncalibrated.

REDUCE PEAK POWER: indicates a combination of OUTPUT LEVEL and amplitude modulation that exceeds specified limits. This allows 100% AM on all OUTPUT LEVEL ranges except the +20 dBm range. In instruments with the Internal Doubler (Option 002), on the 512-1024 MHz range, the peak envelope power of the carrier may not exceed the maximum level of any OUTPUT LEVEL range.

REDUCE FM VERNIER: indicates that an external FM input level or vernier setting is causing FM deviation to exceed limits.

Figure 3-2. Front Panel Controls, Indicators, and Connectors (1 of 4)

FRONT PANEL FEATURES

REDUCE PEAK DEVIATION: indicates PEAK DEVIATION setting is too high for the selected frequency range.

- 5 **COUNTER MODE:** buttons control operation of frequency counter.

EXPAND: X10 expands resolution one digit, moving the decimal point one place to the left; X100 expands resolution two digits, moving the decimal point two places to the left.

NOTE

EXPAND X10 and EXPAND X100 buttons are interlocked so that only one button can be depressed at a time.

LOCK: phase locks Signal Generator to the internal (or to an external) crystal reference. Display indicates lock frequency; loss of lock causes display to blink and indicate actual frequency of Signal Generator.

INT/EXT Source: programs counter to count frequency of Signal Generator (INT) or external input (EXT).

EXT Range: 0-10 or 10-550 selects counter frequency range in MHz when INT/EXT switch set to EXT.

+½ DIGIT: Increases frequency of phase locked generator ½ least significant digit and causes a 5 to appear as a seventh digit on the display. The Signal Generator must be phase locked to initiate +½ DIGIT operation.

- 6 **FREQUENCY MHz:** counter readout indicates RF frequency in MHz. Blinking display indicates loss of phase lock. The OVERFLOW lamp lights to indicate that significant data is not being displayed. Generator cannot be phase locked if an overflow condition is present.

- 7 **TIME BASE VERN:** used as a fine frequency tune when in lock mode to give continuous tuning between lock points (the use of the COUNTER MODE EXPAND X10 control is necessary on

some ranges to tune over the full range). When control is not in CAL position, the UNCAL lamp lights to indicate that the counter is uncalibrated.

- 8 **Time Base Adjust:** allows front panel access to time base calibration potentiometer for easy adjustment of internal reference oscillator.

- 9 **RF ON/OFF:** enables or disables the RF output.

NOTE

The RF ON/OFF switch is wired to turn off only the amplitude modulator. This allows the RF Oscillator to remain warmed up, the Auxiliary RF Output to remain on, and the counter and phase lock to remain operating. If it is desirable to switch both the modulator and the RF Oscillator off, the RF ON/OFF function can be easily modified (see Service Sheet 5 in Section VIII).

- 10 **RF OUTPUT:** RF output through Type N female connector. (Connector meets US MIL-C-39012.) 50 ohm ac coupled source impedance.

CAUTION

If not protected by Option 003 (Reverse Power Protection), application of > 40 Vdc or +13 dBm of RF power into the output jack of the Signal Generator is likely to cause damage to the output circuits of the instrument.

- 11 **OUTPUT LEVEL:** the switch controls a 10 dB step attenuator that sets the output level range. Concentric vernier sets output level within an 18 dB range (the meter indicates actual output).

NOTE

For optimum operation, use the vernier in the top 10 dB of its range.

- 12 **FINE TUNE:** fine frequency control.

Figure 3-2. Front Panel Controls, Indicators, and Connectors (2 of 4)

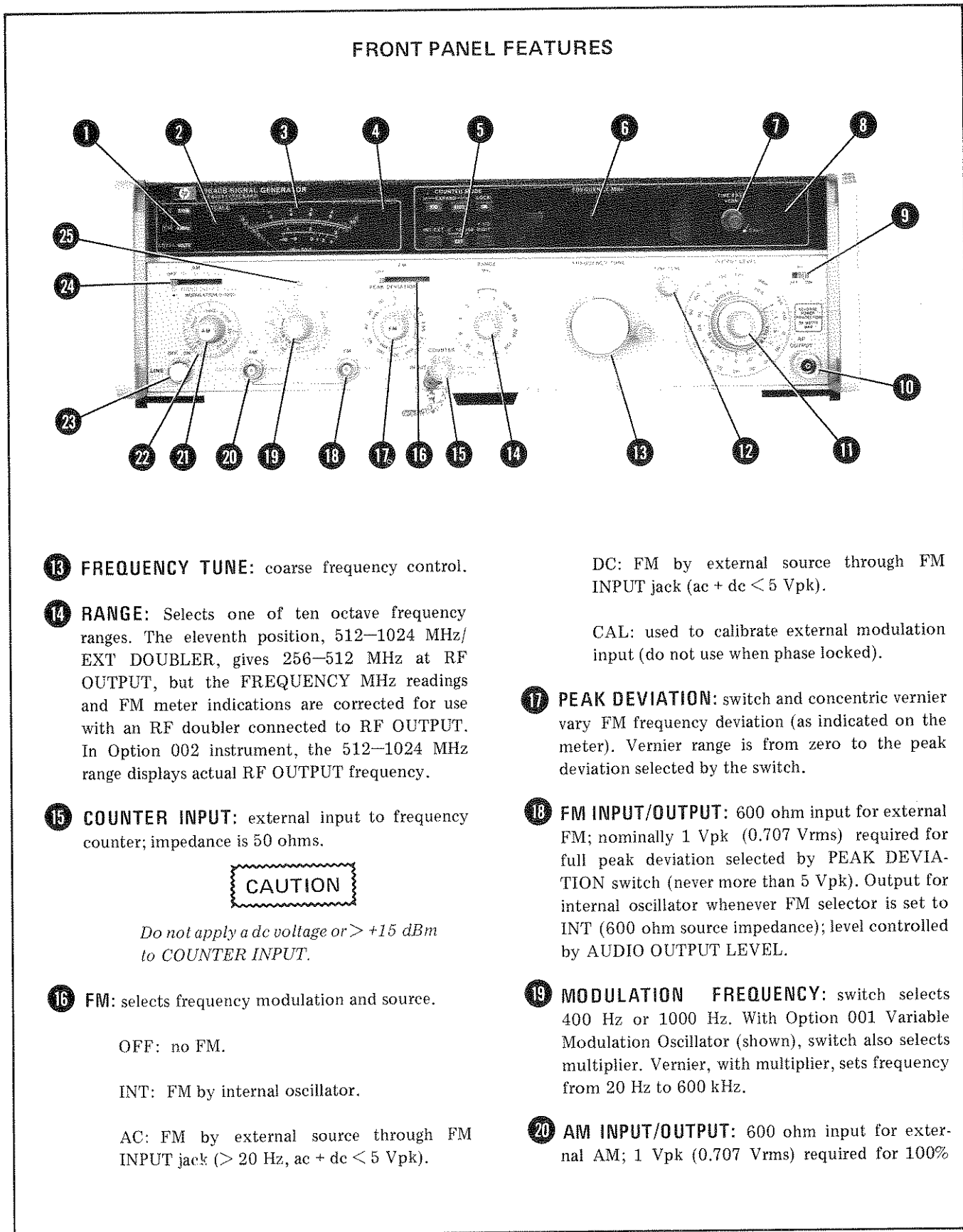

Figure 3-2. Front Panel Controls, Indicators, and Connectors (3 of 4)

FRONT PANEL FEATURES

modulation (never more than 5 Vpk). Input for pulse modulation (50 ohm): > 0.5 Vpk positive pulse required to turn on RF. Output for internal oscillator whenever AM selector is set to INT (600 ohm source impedance): level controlled by AUDIO OUTPUT LEVEL.

NOTE

With the Option 001 Variable Modulation Oscillator, AM OUTPUT and FM OUTPUT are in parallel. Parallel load should be ≥ 600 ohms.

- 21 **MODULATION:** vernier varies amplitude modulation from 0 to 100% (as indicated on the meter).
- 22 **AUDIO OUTPUT LEVEL:** control varies level of signal from AM and/or FM OUTPUT jacks (calibration gives voltage into 600 Ω).
- 23 **LINE:** switch applies or removes AC power. The button is lighted when ON.
- 24 **AM:** selects amplitude modulation and source.
 - OFF: no AM.
 - INT: AM by internal oscillator.
 - AC: AM by external source through AM INPUT jack (> 20 Hz, ac + dc < 5 Vpk).
 - DC: AM by external source through AM INPUT jack (ac + dc < 5 Vpk).
 - PULSE: when selected with no modulation, it disables the RF output; a positive pulse at AM INPUT pulses on the RF.
- 25 **Mechanical Meter Zero:** sets meter suspension so that meter indicates zero when power is removed and instrument is in normal operating position.

Figure 3-2. Front Panel Controls, Indicators, and Connectors (4 of 4)

REAR PANEL FEATURES

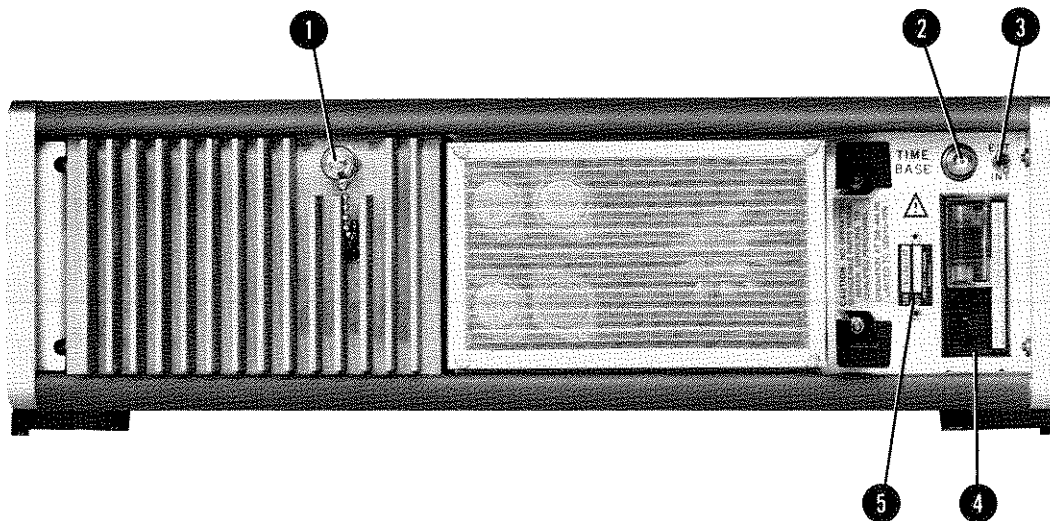

- 1 **AUX RF OUTPUT:** nominal -5 dBm auxiliary RF output; 500 ohm source impedance. Signal does not contain amplitude or pulse modulation (however, it does contain FM). In all instruments, on the 512–1024 MHz range the auxiliary RF output is one-half the frequency of the indicated RF frequency.
- 2 **TIME BASE Reference In/Out:** input for external 5 MHz time base reference that is > 100 mVrms; load impedance is 1 k Ω . Output for internal, 5 MHz time base reference, level is 3 Vrms into an open circuit; source impedance is 500 ohms.

NOTE

Internal jumpers may be repositioned to provide for 1 MHz time base reference input/output operation. See Service Sheet 19 in Section VIII.

- 3 **TIME BASE Reference INT/EXT:** switch selects function of IN/OUT jack. INT position applies internal reference to jack. EXT position feeds external reference from jack to time base.

NOTE

Since the phase lock reference is the 5 MHz time base, the Model 8640B can

be phase locked to an external reference (such as another Model 8640B) by using the TIME BASE Reference jack and switch.

- 4 **Line Power Module:** permits operation from 100, 120, 220 or 240 Vac. The number visible in window indicates nominal line voltage to which instrument must be connected (see Figure 2-1). Center conductor is safety earth ground.

WARNING

Any interruption of the protective (grounding) conductor inside or outside the instrument or disconnection of the protective earth terminal is likely to make the instrument dangerous. Intentional interruption is prohibited.

- 5 **Serial Number Plate:** first four digits and letter of serial number constitute the prefix which defines the instrument configuration; last five digits form sequential suffix that is unique to each instrument. The plate also indicates any options supplied with instrument.

Figure 3-3. Rear Panel Controls and Connectors

OPERATOR'S CHECKS

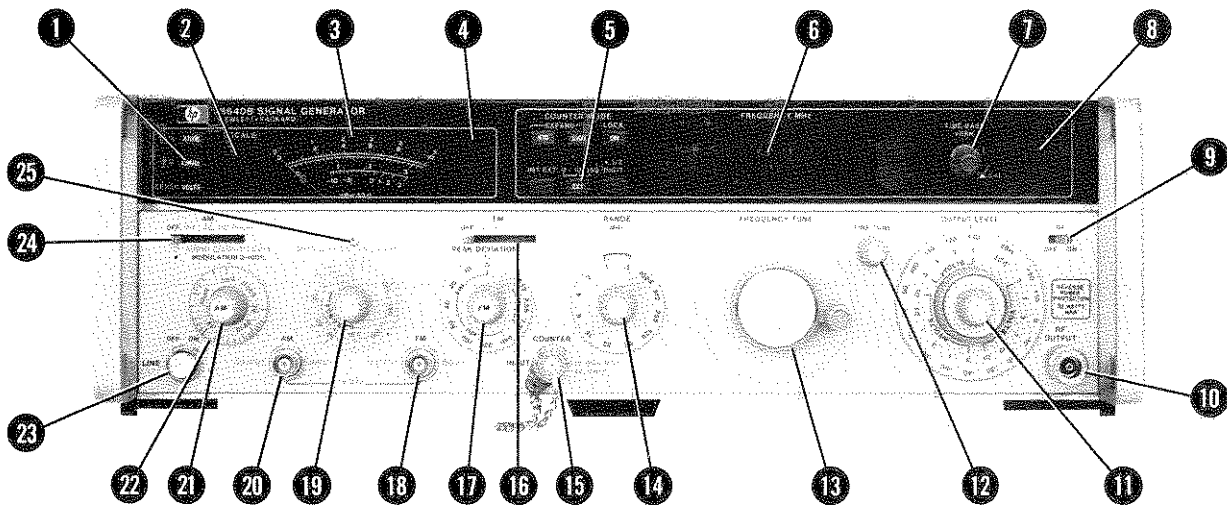

INITIAL CONTROL SETTINGS

- a. Push LINE switch **23** to ON. Set TIME BASE INT/EXT switch (on rear panel) to INT.
- b. Set the controls as follows:

- 1** Meter Function LEVEL
- 5** COUNTER MODE: EXPAND Off (Out)
- LOCK Off (Out)
- Source INT (In)
- +½ DIGIT Off (Out)
- 7** TIME BASE VERN CAL
- 24** AM OFF
- 22** AUDIO OUTPUT LEVEL Fully ccw
- 21** MODULATION Fully ccw
- 19** MODULATION FREQUENCY 400 Hz
- 16** FM OFF
- 17** PEAK DEVIATION 5 kHz
- 17** PEAK DEVIATION Vernier Fully ccw
- 14** RANGE 0.5–1 MHz
- 13** FREQUENCY TUNE Centered (four turns from stop)
- 12** FINE TUNE Centered (2.5 turns from stop)
- 11** OUTPUT LEVEL Switch 0.1 VOLTS (–10 dBm)
- 11** OUTPUT LEVEL Vernier Meter reads 10 (+3 dB)
- 9** RF ON/OFF ON

Figure 3-4. Operator's Checks (1 of 5)

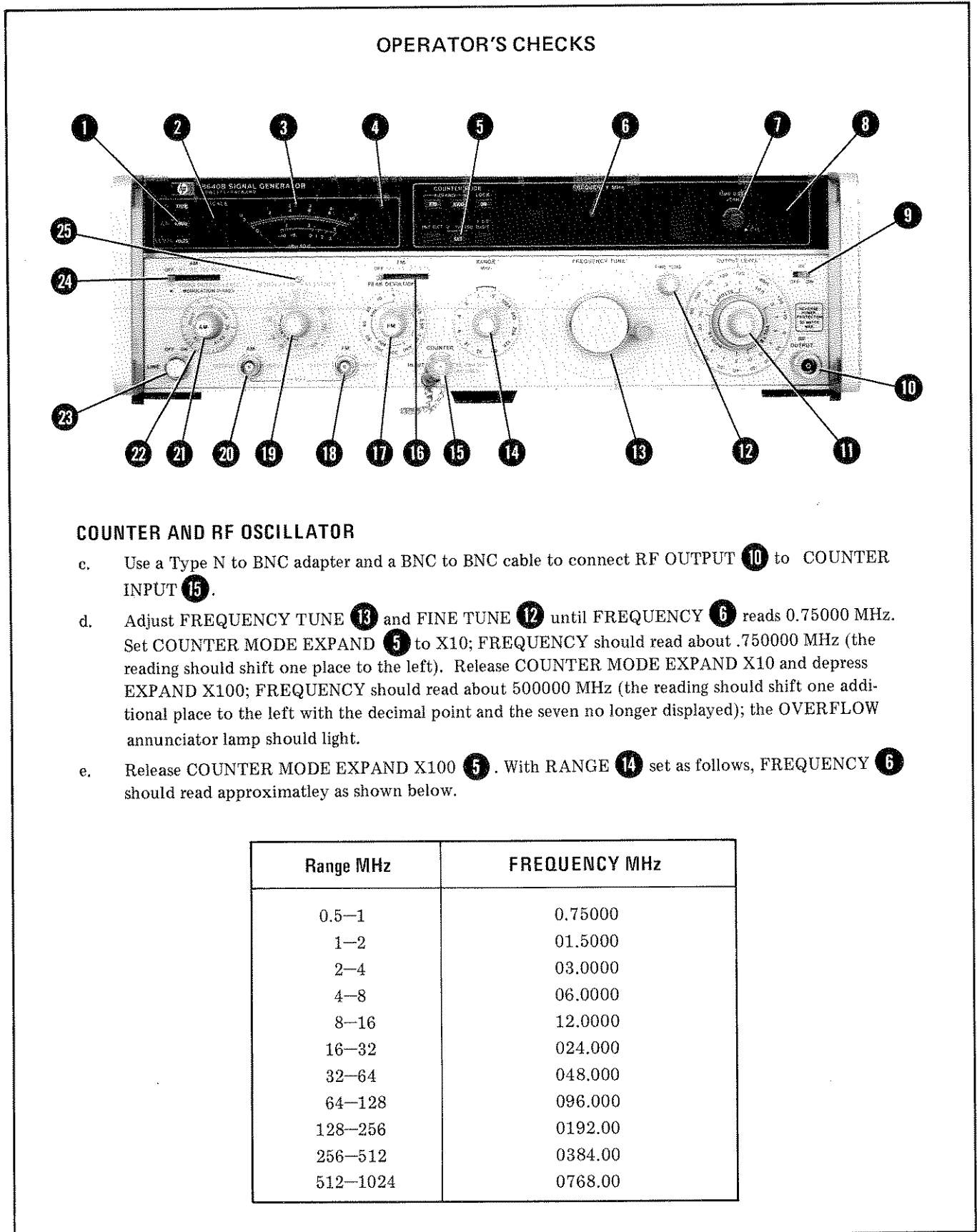

Figure 3-4. Operator's Checks (2 of 5)

OPERATOR'S CHECKS

PHASE LOCK

- f. Set RANGE **14** to 256–512 MHz. Note that the right-hand digit on the FREQUENCY display **6** flickers between two digits. Set COUNTER MODE LOCK **5** to ON; the flickering should stop. Depress $\frac{1}{2}$ DIGIT button; the FREQUENCY display should read 0384.005. Slowly adjust FINE TUNE **12** one-quarter turn; the FREQUENCY reading should not change. Adjust FREQUENCY TUNE **13** one-quarter turn; the FREQUENCY display should blink at about a 2 Hz rate and the reading should change (the reading should follow FREQUENCY TUNE).

Set COUNTER MODE LOCK and $\frac{1}{2}$ DIGIT **5** to off. Set FREQUENCY TUNE to approximately 500 MHz. Turn TIME BASE VERN **7** ccw until it just clicks out of its detent. UNCAL annunciator should light and FREQUENCY should read low by at least 10 kHz. Turn TIME BASE VERN fully ccw, FREQUENCY should read high by at least 10 kHz.

NOTE

The above step is simply a check of TIME BASE VERN operation. The TIME BASE VERN is normally used to vary the RF OUT frequency while the generator is phase locked.

RF OUTPUT

- g. Set Source **5** to EXT and Range to 10–550. Adjust FREQUENCY TUNE **13** until FREQUENCY **6** reads 0384.00 MHz. Step through the ranges specified in step e, setting the COUNTER MODE EXPAND and Range (EXT) control **5** to obtain appropriate resolution; frequency should read approximately as shown in step e.

NOTE

In instruments without the internal doubler (Option 002), when range is set to 512–1024 MHz, the FREQUENCY display will read approximately 0384.00 MHz (the actual frequency at RF OUTPUT). With Option 002, and RANGE set to 512–1024 MHz, when FREQUENCY TUNE is set above 550 MHz, the counter may not display the correct frequency of the output signal.

METER

- h. Set OUTPUT LEVEL switch **11** to 1 VOLT (+10 dBm) and OUTPUT LEVEL vernier **11** until the meter **3** indicates 5 on the 0–10 SCALE; the 0–10 SCALE annunciator **2** should light.
- i. Set OUTPUT LEVEL switch to .3 VOLTS (0 dBm); the 0–3 SCALE annunciator **2** should light.

Figure 3-4. Operator's Checks (3 of 5)

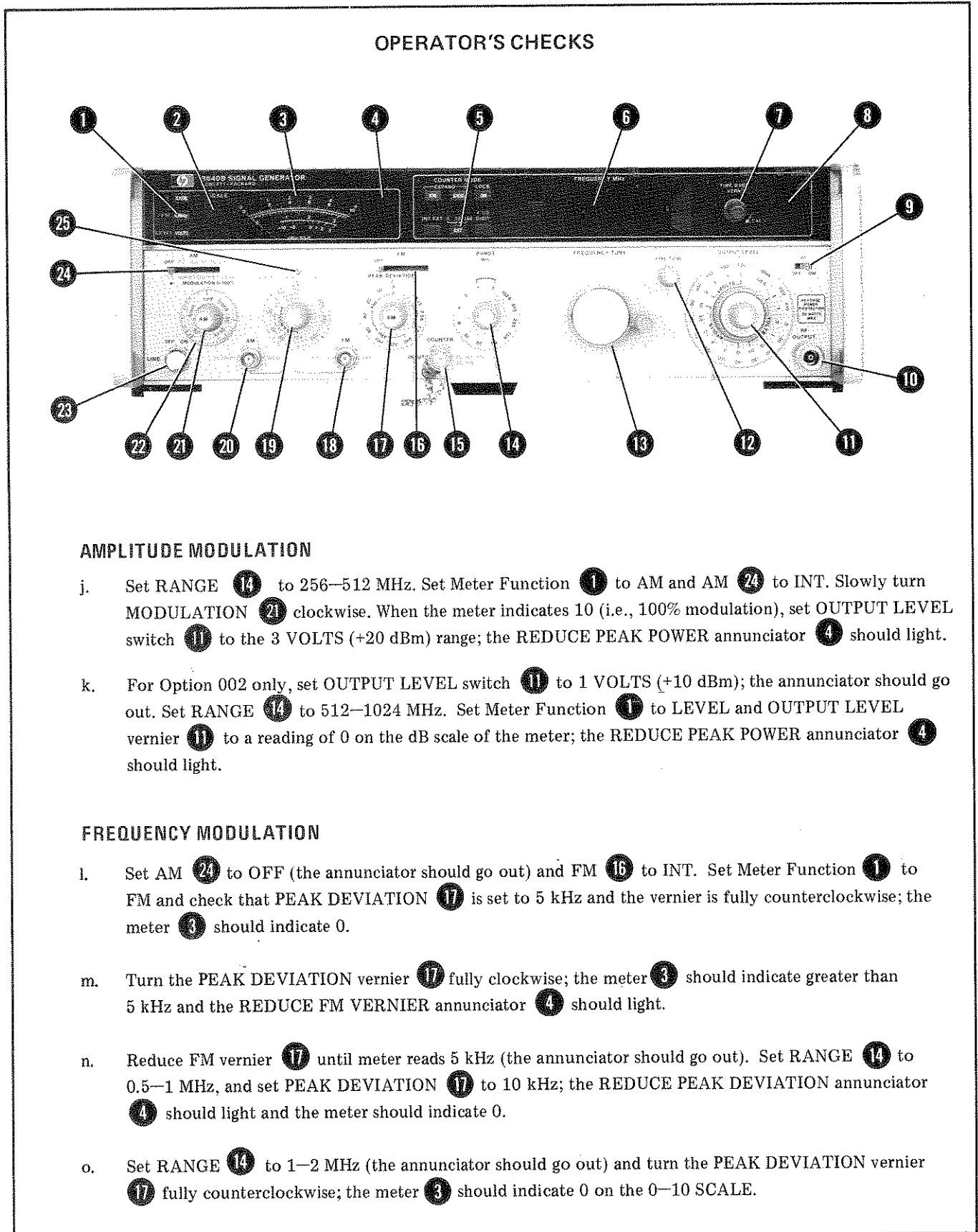

Figure 3-4. Operator's Checks (4 of 5)

OPERATOR'S CHECKS**MODULATION OSCILLATOR**

- p. Using the BNC to BNC cable, connect FM OUTPUT **18** to COUNTER INPUT **15**. Set COUNTER MODE EXPAND **5** to X100 and Source **5** to EXT 0—10. Set AUDIO OUTPUT LEVEL **22** to 1 V and MODULATION FREQUENCY **19**, in turn, to 400 Hz and 1 kHz; the FREQUENCY readout **6** should display approximately “.000400” and “.001000” MHz.

Figure 3-4. Operator's Checks (5 of 5)

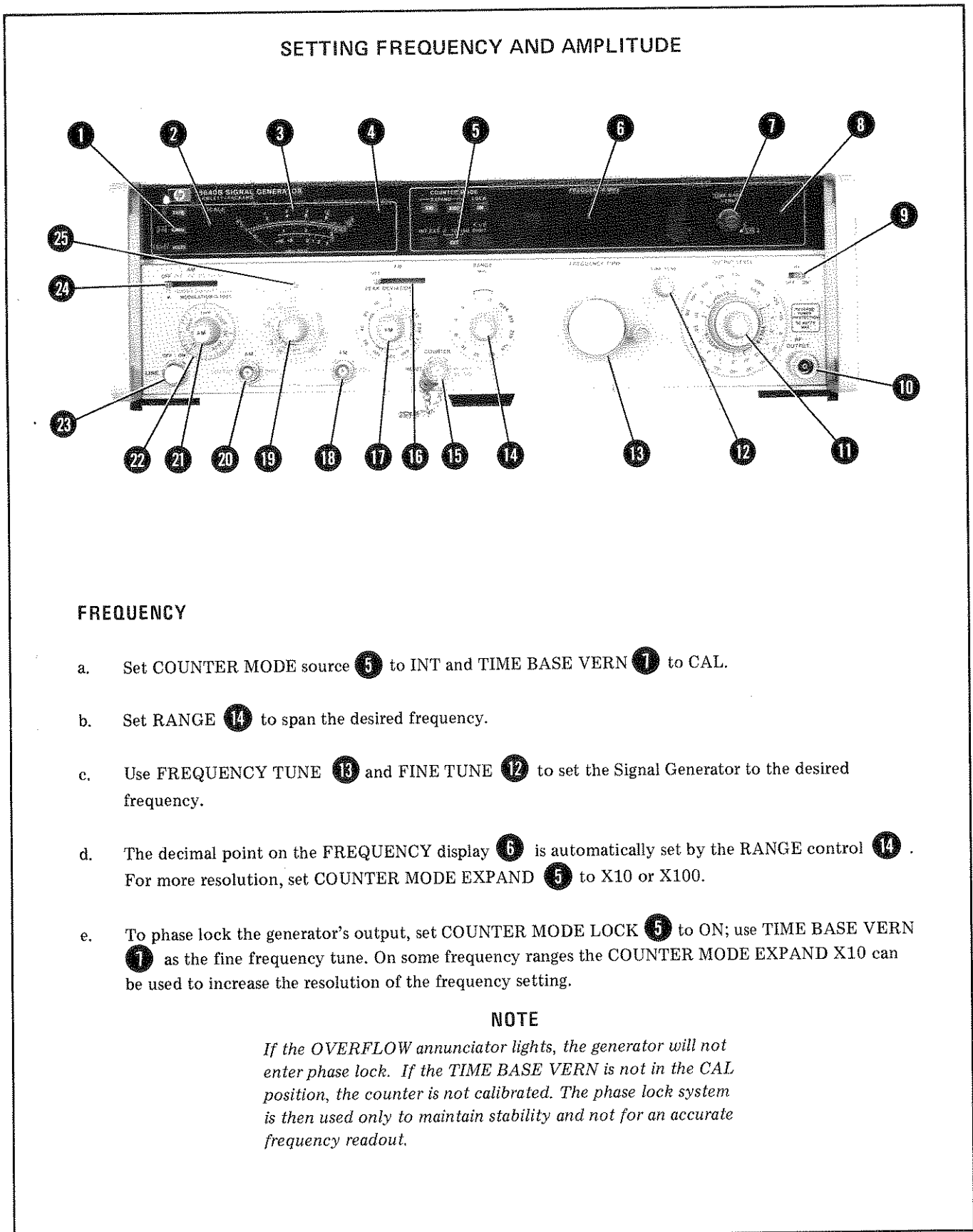

Figure 3-5. Setting the Frequency and Amplitude Controls (1 of 3)

SETTING FREQUENCY AND AMPLITUDE

FREQUENCY (Cont'd)

- f. Whenever phase lock is lost, the FREQUENCY display **6** will blink. To re-establish phase lock, set COUNTER MODE LOCK **5** to off; re-tune (if necessary) with FREQUENCY TUNE **13** and FINE TUNE **12**, and set COUNTER MODE LOCK to ON.
- g. To use the $\pm\frac{1}{2}$ DIGIT function, depress both LOCK and $\pm\frac{1}{2}$ DIGIT buttons; a seventh (least significant) digit (5) will appear on the FREQUENCY display **6**.

NOTE

*The TIME BASE VERN **1** is normally not used with the $\pm\frac{1}{2}$ DIGIT function.*

- h. For instruments without an internal doubler, to use an external frequency doubler, connect to RF OUTPUT **10** and set RANGE **14** to 512–1024 MHz/EXT DOUBLER. The FREQUENCY display **5** will indicate the frequency out of doubler (i.e., the FREQUENCY display indicates twice the frequency at RF OUTPUT). FM and phase lock are also calibrated in this mode.

AMPLITUDE

- a. Use the OUTPUT LEVEL switch and vernier **11** to set the desired signal level (there are two types of scales, rms volts and dBm). For optimum operation, use the vernier in the top 10 dB of its range. To enable the RF OUTPUT signal, set the RF ON/OFF switch **9** to ON.

CAUTION

For instruments with Option 003 (reverse power protection) avoid control settings which cause the REDUCE PEAK POWER annunciator to light. The Signal Generator's own output can trip the level sensor. This may occur with high peak envelope power AM signals or during low RF frequency, open-circuit operation. This condition can cause relay contact chatter and reduce contact life.

NOTE

The RF ON/OFF switch may be wired to turn off the amplitude modulator or both the amplitude modulator and the RF Oscillator (see Service Sheet 5 in Section VIII).

- b. To read the output level, set Meter Function **1** to LEVEL. The meter **3** is read in conjunction with the OUTPUT LEVEL control **11** (e.g., with OUTPUT LEVEL switch set to .03 VOLTS, a meter reading of 2.1 indicates that the actual level is 21 mVrms).

Figure 3-5. Setting the Frequency and Amplitude Controls (2 of 3)

SETTING FREQUENCY AND AMPLITUDE**AMPLITUDE (Cont'd)**

- c. If a 50 ohm to 75 ohm adapter (consisting of a 25 ohm series resistor) is connected to RF OUTPUT **10**, the OUTPUT LEVEL **11** voltage scale will be correct if the instrument is used with 75 ohm terminations. However, 1.76 dB must be subtracted from the dB scale for correct readings.

Figure 3-5. Setting the Frequency and Amplitude Controls (3 of 3)

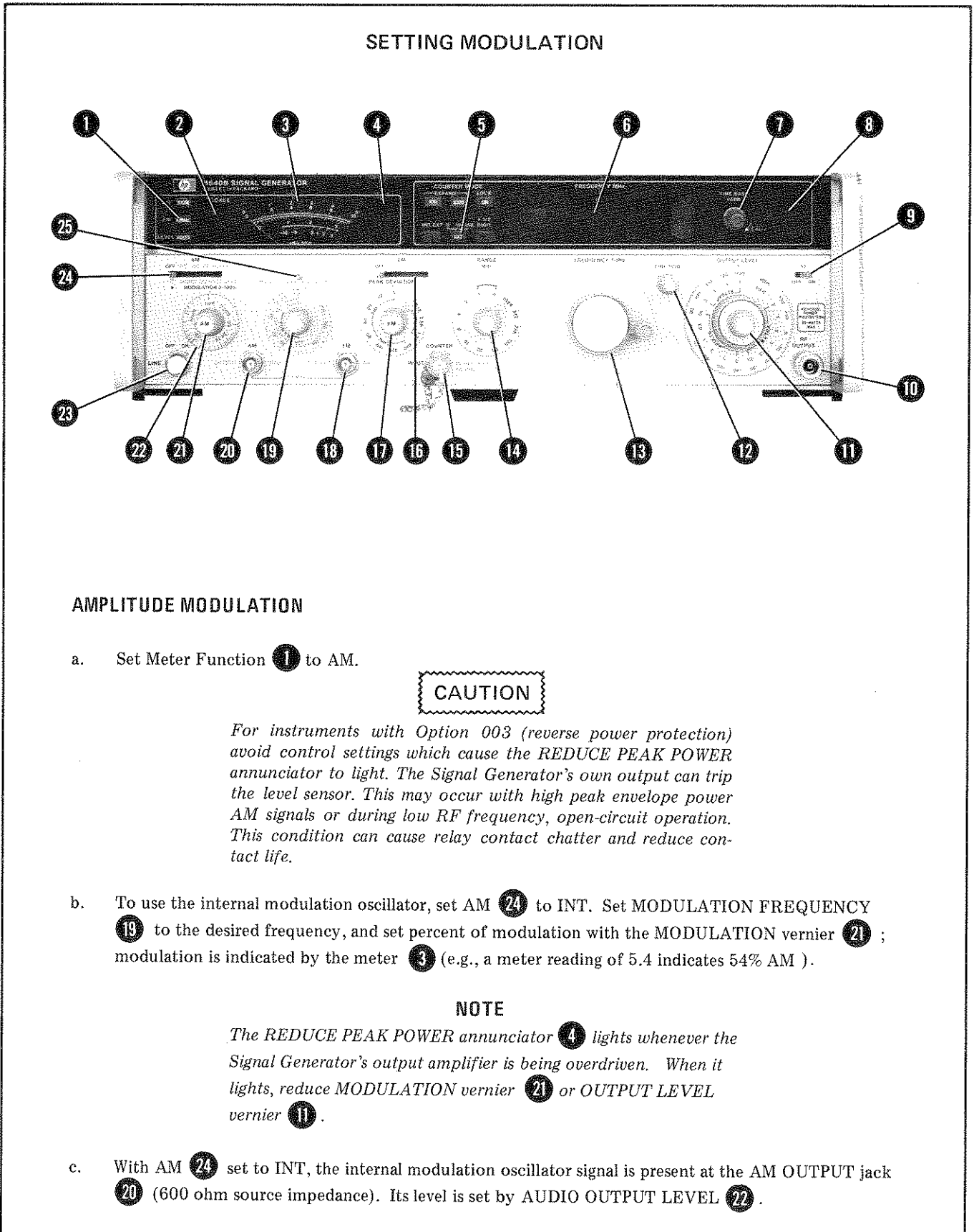

Figure 3-6. Setting the Modulation Controls (1 of 4)

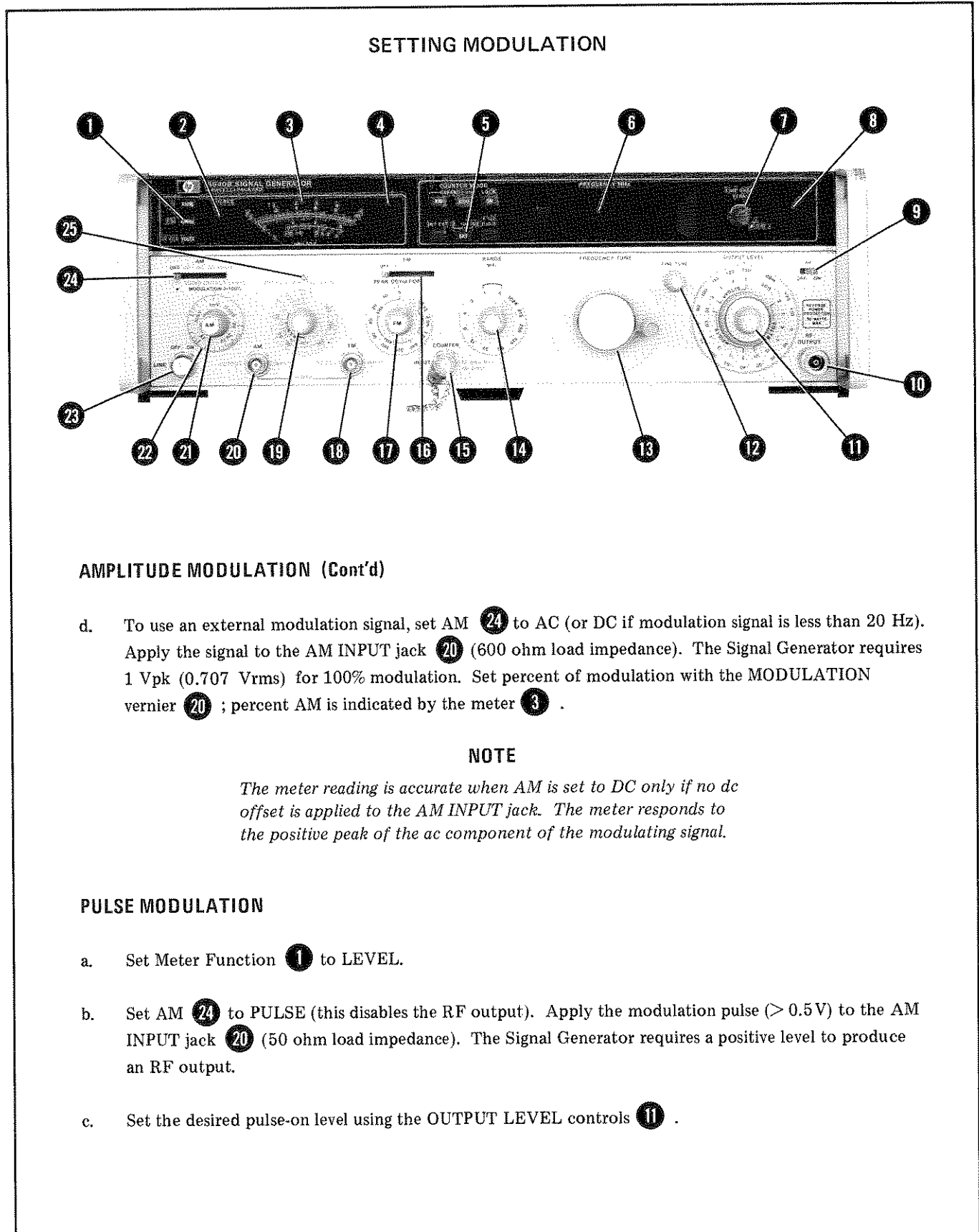

Figure 3-6. Setting the Modulation Controls (2 of 4)

SETTING MODULATION

FREQUENCY MODULATION

- a. Set Meter Function **1** to FM.
- b. To use the internal modulation oscillator, set FM **16** to INT. Set MODULATION FREQUENCY **19** to the desired frequency, and set the peak deviation with the PEAK DEVIATION switch and vernier **17**.

NOTE

*The REDUCE PEAK DEVIATION annunciator **4** lights whenever the PEAK DEVIATION switch setting is too high for the selected frequency range. When it lights, reduce PEAK DEVIATION range.*

- c. Peak frequency deviation is indicated by the meter **3**, and the meter is read in conjunction with the PEAK DEVIATION switch **17** (e.g., with PEAK DEVIATION set to 320 kHz, a meter reading of 2.8 indicates that peak frequency deviation is 280 kHz).
- d. With FM **16** set to INT, the internal modulation oscillator signal is present at the FM OUTPUT jack **18** (600 ohm source impedance). Its level is set by AUDIO OUTPUT LEVEL **22**.
- e. To use an external modulation signal, set FM **16** to AC (or DC if modulation signal is less than 20 Hz). Apply the signal to the FM INPUT jack **18** (600 ohm load impedance). The Signal Generator requires 1 Vpk (0.707 Vrms) for full peak deviation. The PEAK DEVIATION controls **17** and the meter **3** are used the same way as when using the internal modulation oscillator signal.
- f. To calibrate the external input, set the FM switch **16** to DC (with no signal applied to FM input) and read the frequency of the RF OUTPUT. Set FM to CAL and, using the PEAK DEVIATION switch and vernier **17**, offset the frequency at RF OUTPUT an amount equal to the desired peak deviation. Set FM **16** to DC or AC; a 1 Vpk (0.707 Vrms) signal applied to FM INPUT **18** will now produce the desired peak deviation. (Do not use FM CAL when phase locked.)

NOTES

*The REDUCE FM VERNIER annunciator **4** lights when an FM input causes peak deviation to exceed its limits. When it lights, reduce either the PEAK DEVIATION vernier or the external signal level.*

Do not apply signals that are less than 50 Hz when using the generator in the phase lock mode. Doing so will cause either the FM deviation to be uncalibrated or the generator to break phase lock (thereby causing the counter display to blink). Also do not use FM CAL after locking.

Figure 3-6. Setting the Modulation Controls (3 of 4)

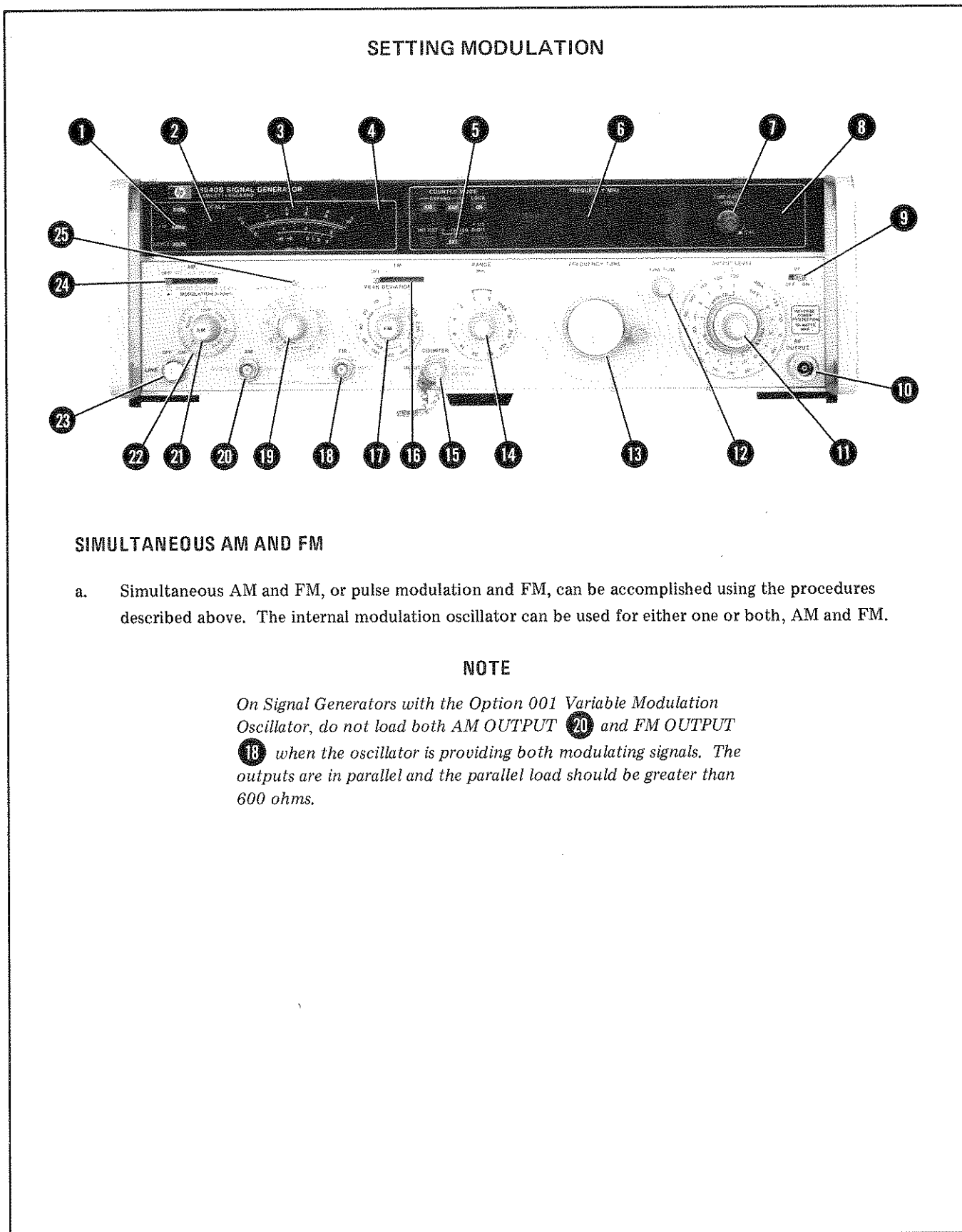

Figure 3-6. Setting the Modulation Controls (4 of 4)

3-15. OPTION 002 AM CALIBRATION PROCEDURE (512–1024 MHz Range Only)

REFERENCE: Service Sheet 14.

DESCRIPTION: On the 512–1024 MHz range, % AM varies both with FREQUENCY and OUTPUT LEVEL vernier setting. Each instrument can be calibrated at a given frequency and output level by this procedure. % AM is calibrated while comparing the actual amount of amplitude modulation to the level of the input modulating signal. The AM is demodulated by a spectrum analyzer in the zero span mode. A DVM is used to measure the ac and dc voltages at the analyzer's vertical output. The dc voltage corresponding to the carrier level is set to 282.8 mVdc. The rms value of the modulation is then a very accurate measure of AM percent (% AM is 1/2 the ac voltage in mVrms).

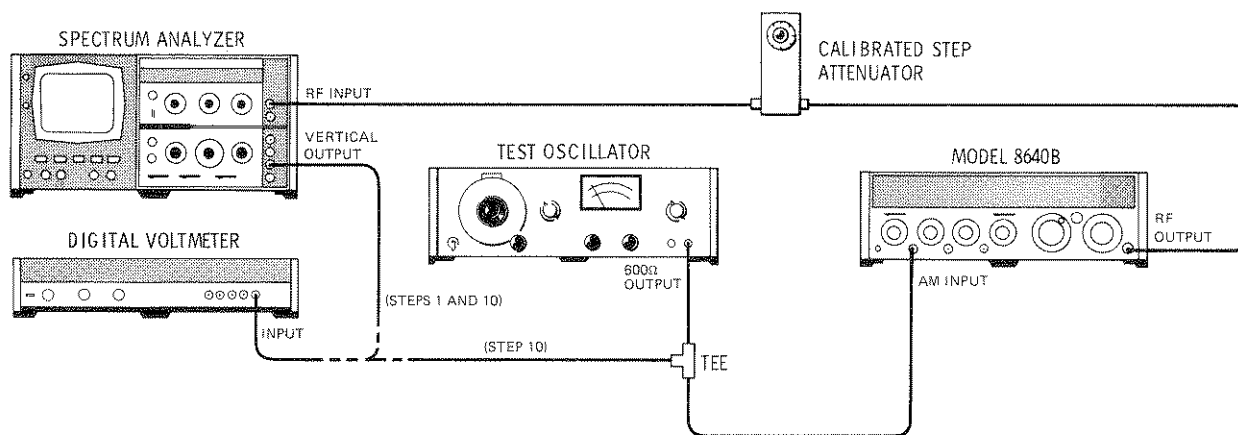

Figure 3-7. Option 002 AM Calibration Test Setup (512–1024 MHz Range Only)

EQUIPMENT:

Spectrum Analyzer	HP 8554B/8552B/141T
Digital Voltmeter	HP 3490A
Test Oscillator	HP 651B
10 dB Step Attenuator.	HP 355D

PROCEDURE: 1. Connect equipment as shown in Figure 3-7 after setting Signal Generator's controls as follows:

- COUNTER MODE: EXPAND . . . Off
- LOCK Off
- +½ DIGIT. . . Off
- Source INT
- Meter Function LEVEL
- AM OFF
- MODULATION Fully ccw
- FM OFF
- RANGE 2–3 MHz
- FREQUENCY TUNE 3 MHz
- OUTPUT LEVEL Switch –30 dBm
- OUTPUT LEVEL Vernier Meter reads +3 dB
- RF ON/OFF ON

2. Set step attenuator to 0 dB.

3-15. OPTION 002 AM CALIBRATION PROCEDURE (512–1024 MHz Range Only) (Cont'd)

3. Set spectrum analyzer's resolution bandwidth to 300 kHz, input attenuation to 20 dB, frequency span per division (scan width) to 20 kHz (tuning stabilizer on), scale to linear, and adjust center frequency and scale reference level controls to center the 3 MHz signal on the display. Set frequency span per division to 0 Hz and display smoothing (video filter) to 10 kHz. Peak the signal on the display with center frequency controls.
4. Adjust analyzer's reference level controls for -500 mVdc indicated on DVM ($V_{DET 1}$).
5. Set step attenuator to 20 dB. Note DVM reading ($V_{DET 2}$).
6. Calculate V_{off} , where

$$V_{off} = \frac{V_{DET 2} - \alpha V_{DET 1}}{1 - \alpha}$$

and $\alpha = V_{RF 2}/V_{RF 1}$ (i.e., α = attenuation; for 20 dB it is 0.1),

therefore

$$V_{off} = \frac{V_{DET 2} + 50 \text{ mVdc}}{0.9} = \text{_____ mVdc.}$$

7. Set step attenuator to 0 dB.
8. Set generator's controls as follows:

Meter Function	AM
AM	AC
RANGE	512–1024 MHz
FREQUENCY TUNE	As desired
9. Set analyzer's center frequency controls to peak the signal on the display.
10. Set generator's MODULATION control fully cw. Connect the DVM to spectrum analyzer's vertical output.
11. Use analyzer's reference level controls to set $-282.8 \text{ mVdc} + V_{off}$ at vertical output (as measured on the DVM). For example, if V_{off} is +50.0 mVdc, then set $-282.8 \text{ mVdc} + (+50.0 \text{ mVdc})$ or -232.8 mVdc at vertical output. (Check that signal is peaked on analyzer display.)
12. To measure % AM, set the DVM to measure mVrms (ac only). Adjust the test oscillator to give the desired % AM which is equal to 1/2 the voltage reading (e.g., 100 mVrms equals 50% AM).

3-15. OPTION 002 AM CALIBRATION PROCEDURE (512–1024 MHz Range Only) (Cont'd)**NOTE**

Should the AM peak power exceed -27 dBm, the REDUCE PEAK POWER annunciator will light. In such a case reduce the OUTPUT LEVEL vernier until the light goes out, then readjust the analyzer's dc output level as in step 5, and continue.

13. Note the AM panel meter reading and the test oscillator output level (as measured with DVM).

NOTE

This calibrates the actual AM against the input modulation sensitivity and meter indication. The meter indication now applies for both external and internal AM.

14. Repeat steps 12 and 13 for other desired levels of % AM.
15. Repeat steps 11 through 14 for other desired OUTPUT LEVEL vernier settings.

NOTE

For a given OUTPUT LEVEL vernier setting, the AM calibration applies for the same setting on other OUTPUT LEVEL ranges.

16. Repeat steps 2 through 15 for other desired RF frequencies on the 512–1024 MHz range.

